

# Ssc Gd Constable Tier I Previous Year Question Paper Overview

Here, you can solve all the questions asked in Ssc Gd Constable Tier I Previous Year Question Paper on 2023-01-12 in the Morning exam. The detailed solutions are also provided for every previous year question and some of these questions can be asked again in your Ssc Gd Constable Tier I exam. There are 80 questions in the exam and 60 minutes are provided for the Ssc Gd Constable Tier I exam. The Cutoff of the exam was 120 marks hence you should try to score at least 130 marks.

# Ssc Gd Constable Tier I Previous Year Question Paper : Questions and Solutions

## Question 1 :

Select the correct mirror image of the given figure when the mirror is placed at MN as shown below.

Difficulty : Moderate

Average Time : 45 Seconds

## Options :

1. J I e @ † w u n m
2. J I @ e † w u n m
3. J I @ e † m u n w
4. J I e @ † m u n w

## Solution :

The correct answer is **option 2** i.e. J I @ e † w u n m.

The mirror image of the question figure is shown below:



Since the mirror is placed right to the question figure, the right-hand side of the original image will now be the left-hand side of the mirror image.

Hence, **option 2** is the correct answer.

**Question 2 :**

6 persons – A, B, C, D, E, and F are sitting around a circular table facing away from the centre. B sits immediate left of A. F is sitting immediate right to A. E is sitting immediately adjacent to F and D. C is sitting immediate right to D. Who among the following is sitting immediately adjacent to A and C?

**Difficulty : Moderate****Average Time : 85 Seconds****Options :**

1. B
2. F
3. E
4. D

**Solution :**

The correct answer is **Option 1** i.e. **B**

1. B sits immediate left of A.
2. F is sitting immediate right of A.
3. E is sitting immediately next to F and D.
4. C is sitting immediate right of D.

This is our final arrangement.

Clearly, B is sitting immediately adjacent to A and C.

Hence, the correct answer is **B**.

**Question 3 :**

Eight friends P, Q, R, S, T, U, V, and W are sitting in two rows facing each other. Each row has four persons. Q and R are sitting in front of each other. R is the immediate neighbour of S and T. W is sitting to the immediate left of T. W and U are diagonally opposite. V and Q are not next to each other. Who is in front of T?

**Difficulty : Moderate****Average Time : 65 Seconds****Options :**

1. Q

R

3. P

4. S

**Solution :**

The correct answer is **option 3** i.e. **P**.

According to the question, the arrangement is as follows:

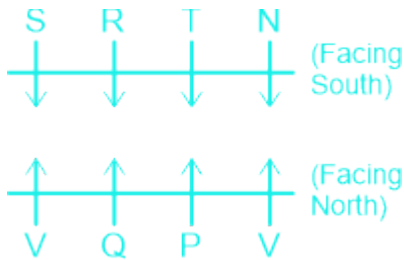

From the above arrangement, P is in front of T.

**Question 4 :**

The sequence of folding a piece of paper and the manner in which the folded paper has been cut is shown below. Select the figure which would most closely resemble the unfolded form of the paper.

Difficulty : Moderate

Average Time : 48 Seconds

**Options :**

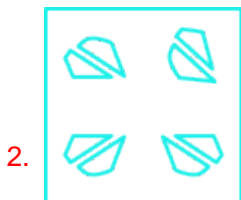
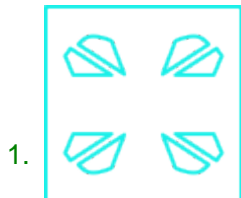

3.

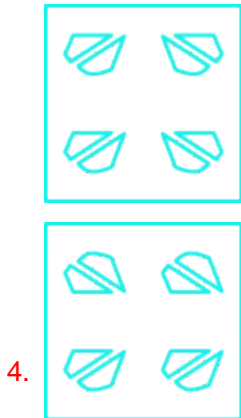

**Solution :**



The correct answer is **option 1** i.e.

After unfolding, the paper will appear as follows:

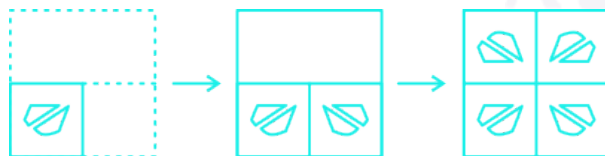

**Question 5 :**

Select the option that is related to the fifth letter-cluster in the same way as the second letter-cluster is related to the first letter-cluster and the fourth letter-cluster is related to the third letter-cluster. KSW: NUX:: AGP: DIQ:: EOY:?

**Difficulty : Moderate**

**Average Time : 68 Seconds**

**Options :**

1. BQU
2. HQW
3. BQW
4. HOW

**Solution :**

The correct answer is **option 2** i.e. HQW.



The logic used here is:

KSW: NUX

$K + 3 = N$

$S + 2 = U$

$W + 1 = X$

AGP: DIQ

$A + 3 = D$

$G + 2 = I$

$P + 1 = Q$

Similarly,

EOV:?

$E + 3 = H$

$O + 2 = Q$

$V + 1 = W$

Hence, **option 2** is the correct answer.

**Question 6 :**

In a certain code language, 'FAVOUR' is written as 'RUOVAF', and 'REVEAL' is written as 'LAEVER'. How will 'MIRACLE' be written in that language?

**Difficulty : Moderate**

**Average Time : 54 Seconds**

**Options :**

1. ECLRAIM
2. ELCARIM
3. ECLARMI
4. EMLCRIA

**Solution :**

The correct answer is **option 2** i.e. **ELCARIM**.

The logic used here is:

'FAVOUR' is written as 'RUOVAF'

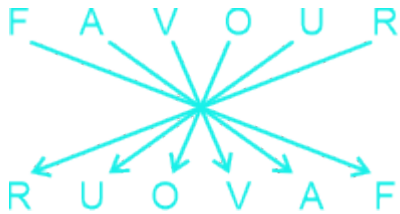

'REVEAL' is written as 'LAEVER'

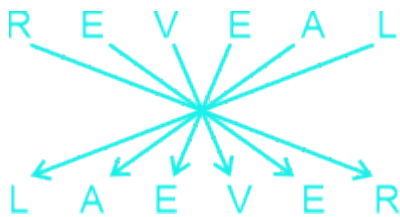

Similarly;

**Code for the word MIRACLE:**



Hence, **option 2** is the correct answer.

**Question 7 :**

Which letter cluster will replace the question mark (?) to complete the given series? SEJW, QGMT, OIPQ,?, KMVK

Difficulty : Moderate

Average Time : 61 Seconds

**Options :**

1. MKTN
2. MKTM
3. MKMT
4. MKSN

**Solution :**

The correct answer is **option 4 i.e. MKSN.**

Given series: SEJW, QGMT, OIPQ,?, KMKV

The series follows this pattern:

SEJW, QGMT

$$S - 2 = Q$$

$$E + 2 = G$$

$$J + 3 = M$$

$$W - 3 = T$$

Similarly;

OIPQ,?

$$O - 2 = M$$

$$I + 2 = K$$

$$P + 3 = S$$

$$Q - 3 = N$$

So, the missing term in the series is **MKSN.**

#### Question 8 :

In a certain code language, 'HUSBAND' is written as 'DNABSUH', and 'CLEARLY' is written as 'YLRAELC'. How will 'HARBOUR' be written in that language?

Difficulty : Moderate

Average Time : 56 Seconds

#### Options :

1. RUOBRHA
2. ORUBRAH
3. ORUBHRA
4. RUOBRAH

#### Solution :

The correct answer is **option 4 i.e. RUOBRAH.**

The logic used here is:

'HUSBAND' is written as 'DNABSUH'

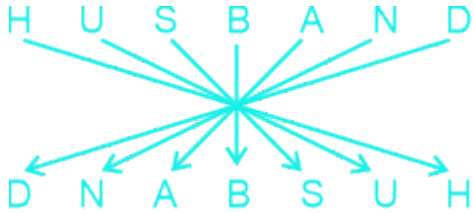

'CLEARLY' is written as 'YLRAELC'



Similarly;

**Code for the word HARBOUR:**

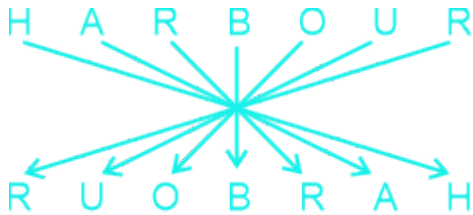

Hence, **option 4** is the correct answer.

**Question 9 :**

Select the option figure which is embedded in the given figure.(Rotation is NOT allowed)

Difficulty : Moderate

Average Time : 60 Seconds

Options :



2.



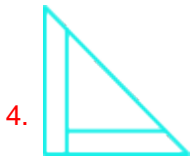
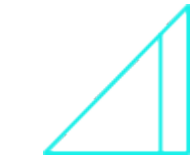

**Solution :**

The correct answer is **option 3** i.e.



The figure in option 3 is embedded in the given figure, as shown below:



**Question 10 :**

Which two signs should be interchanged to make the equation mathematically correct?  $24 + 36 - 81 \times 9 \div 2 = 42$

**Difficulty :** Moderate

**Average Time :** 63 Seconds

**Options :**

1.  $\div$  and  $-$
2.  $\times$  and  $+$
3.  $\div$  and  $\times$
4.  $+$  and  $-$

**Solution :**

The correct answer is **option 3 i.e. ÷ and ×.**

**Given equation:**  $24 + 36 - 81 \times 9 \div 2 = 42$

**Option 1: ÷ and -**

After interchanging the expression becomes:

$$= 24 + 36 \div 81 \times 9 - 2 = 42$$

$$= 24 + 4 - 2$$

$$= 28 - 2$$

$$= 26 \text{ is not equal to } 42.$$

**Option 2: × and +**

After interchanging the expression becomes:

$$= 24 \times 36 - 81 + 9 \div 2 = 42$$

$$= 787.5 \text{ is not equal to } 42.$$

**Option 3: ÷ and ×**

After interchanging the expression becomes:

$$= 24 + 36 - 81 \div 9 \times 2 = 42$$

$$= 24 + 36 - 9 \times 2$$

$$= 60 - 18$$

$$= 42 \text{ is equal to } 42.$$

As we have found our answer, there is no need to check further options.

Hence, **option 3** is the correct answer.

**Question 11 :**

Which option represents the correct order of the given words as they would appear in the English dictionary? 1. Jacket 2. Japanese 3. Jabbed 4. Jackpot 5. Janitor

**Difficulty :** Moderate

**Average Time :** 71 Seconds

**Options :**

3,1,2,5,4,

2. 3,1,4,5,2

3. 3,5,2,1,4

4. 3,2,1,4,5

### Solution :

The correct answer is **option 2** i.e. **3, 1, 4, 5, 2**.

In this question, you need to arrange the words as they would appear in an English dictionary.

1. Jabbed

2. Jacket

3. Jackpot

4. Janitor

5. Japanese

### Question 12 :

Select the option that is related to the fifth letter-cluster in the same way as the second letter-cluster is related to the first letter-cluster and the fourth letter-cluster is related to the third letter-cluster. SURGERY: TVSHFSZ:: SILENCE: TJMFODF:: SOCIETY:?

Difficulty : Moderate

Average Time : 45 Seconds

### Options :

1. YTEICOS

2. TPDJFUZ

3. COSYTEI

4. CIETYSO

### Solution :

The correct answer is **option 2** i.e. **TPDJFUZ**

The logic used here is:

SURGERY: TVSHFSZ

S + 1 = T



**5 LAKH+ STUDENTS**  
Already enrolled with our selection focused courses.



**30+ EXPERT INSTRUCTORS**  
Our instructors are the best in the industry



**10000+ HOURS OF VIDEOS**  
All videos are well-explained for you to get every bit out of the videos

$$U + 1 = V$$

$$R + 1 = S$$

$$G + 1 = H$$

$$E + 1 = F$$

$$R + 1 = S$$

$$Y + 1 = Z$$

SILENCE: TJMFODF

$$S + 1 = T$$

$$I + 1 = J$$

$$L + 1 = M$$

$$E + 1 = F$$

$$N + 1 = O$$

$$C + 1 = D$$

$$E + 1 = F$$

Similarly,

SOCIETY:?

$$S + 1 = T$$

$$O + 1 = P$$

$$C + 1 = D$$

$$I + 1 = J$$

$$E + 1 = F$$

$$T + 1 = U$$

$$Y + 1 = Z$$

Hence, **option 2** is the correct answer.

### Question 13 :

Which of the following numbers will replace the question mark (?) in the given series? 1483, 2369, ?, 4141, 5027, 5913



Difficulty : Moderate

Average Time : 62 Seconds

Options :

1. 3255
2. 2869
3. 3119
4. 3189

Solution :

The correct answer is **option 1** i.e. **3255**.

Given series: 1483, 2369, ?, 4141, 5027, 5913

The series follows this pattern:

$$1483 + 886 = 2369$$

$$2369 + 886 = 3255$$

$$3255 + 886 = 4141$$

$$4141 + 886 = 5027$$

$$5027 + 886 = 5913$$

So, the missing term in the series is **3255**.

Question 14 :

Which of the following terms will replace the question mark (?) in the given series? RHWG, QKVF, ?, OQTL, NTSO

Difficulty : Moderate

Average Time : 40 Seconds

Options :

1. PMUJ
2. PNUI
3. QNUI
4. ONUJ

Solution :

The correct answer is **option 2** i.e. **PNUI**.

Given series: RHCW, QKVF, ?, OQTL, NTSO

The series follows this pattern:

RHCW, QKVF

$$R - 1 = Q$$

$$H + 3 = K$$

$$W - 1 = V$$

$$C + 3 = F$$

Similarly;

QKVF, ?

$$Q - 1 = P$$

$$K + 3 = N$$

$$V - 1 = U$$

$$F + 3 = I$$

So, the missing term in the series is **PNUI**.

### Question 15 :

Select the figure from among the given options that can replace the question mark (?) in the following series.

Difficulty : Moderate

Average Time : 52 Seconds

Options :

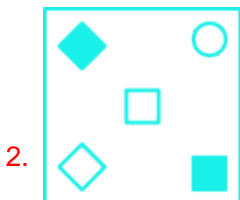
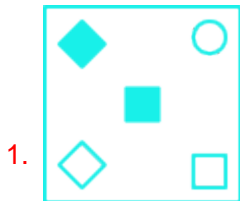

3.

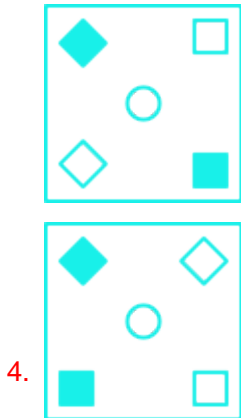

**Solution :**



The correct answer is **Option 3** i.e.

In all the figures in the given series, each figure has appeared once each at the four edges and in the middle, hence the first pattern will be repeated in the next figure.

Hence, the correct answer is **Option 3**.

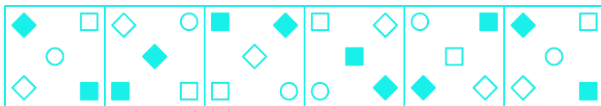

**Question 16 :**

Three Statements are given followed by Three conclusions numbered I, II, and III. Assuming the statements to be true, even if they seem to be at variance with commonly known facts, decide which of the conclusions logically follow(s) from the statements. Statements: Some trees are fish. All fishes are goats. No goat is a flower. Conclusions: I. Some trees are goats. II. Some fishes are not flowers. III. Some flowers are not goats.

**Difficulty :** Moderate

**Average Time :** 87 Seconds

**Options :**

1. Only conclusion I follows.
2. Only conclusion II follows.
3. Only conclusion III follows.

All conclusions follow

**Solution :**

The correct answer is **option 4** i.e. **All conclusions follow.**

The least possible Venn Diagram for the given statements is drawn below:

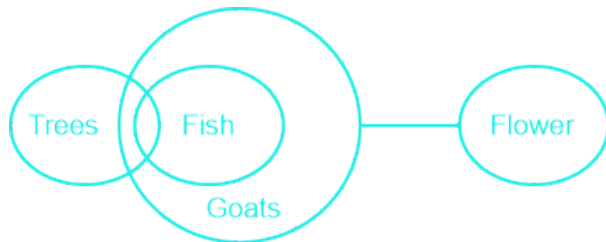
**Conclusions:**

- I. Some trees are goats **True** (As some trees are fish, and all fishes are goats, so, some trees are goats is also true.)
- II. Some fishes are not flowers **True** (As all fishes are goats, and no goat is a flower, so, some fishes are not flowers is also true.)
- III. Some flowers are not goats **True** (As no goat is a flower, so, some flowers are not goats is also true.)

Hence, **All conclusions follow.**

**Question 17 :**

Select the correct combination of mathematical signs to sequentially replace the % signs and to balance the given equation.  $42 \% 7 \% 5 \% 10 \% 3$

Difficulty : Moderate

Average Time : 74 Seconds

**Options :**

- 1.  $\div, \times, =, \times$
- 2.  $\times, =, , \div$
- 3.  $\div, \times, =,$
- 4.  $\times, \div, =,$

**Solution :**

The correct answer is **option 1** i.e.  $\div, \times, =, \times$ .

**Given equation:**  $42 \% 7 \% 5 \% 10 \% 3$

**Option 1:**  $\div, \times, =, \times$





After interchanging the expression becomes:

$$= 42 \div 7 \times 5 = 10 \times 3$$

$$= 6 \times 5 = 10 \times 3$$

= 30 is equal to 30.

As we have found our answer, there is no need to check further options.

Hence, **option 1** is the correct answer.

**Question 18 :**

Which of the following numbers will replace the question mark (?) in the given series? 1, 2, 2, 4, 3, 6, 4, 8, ?

**Difficulty : Moderate**

**Average Time : 51 Seconds**

**Options :**

1. 7

2. 10

3. 5

4. 9

**Solution :**

The correct answer is **option 3** i.e. **5**.

Given series: 1, 2, 2, 4, 3, 6, 4, 8, ?

The series follows this pattern:

1. 1, 2, 3, 4, ?

$$1 + 1 = 2$$

$$2 + 1 = 3$$

$$3 + 1 = 4$$

$$4 + 1 = 5$$

2. 2, 4, 6, 8

$$2 + 2 = 4$$

$$4 + 2 = 6$$



$$6 + 2 = 8$$

So, the next term in the series is **5**.

**Question 19 :**

Select the set in which the numbers are related in the same way as the numbers of the following sets. (NOTE: Operations should be performed on the whole numbers, without breaking down the numbers into their constituent digits. E.g. 13 – Operations on 13 such as adding/subtracting/multiplying etc. to 13 can be performed. Breaking down 13 into 1 and 3 and then performing mathematical operations on 1 and 3 is not allowed) (17, 136, 40) (11, 198, 90)

**Difficulty : Moderate****Average Time : 55 Seconds****Options :**

1. (12, 108, 45)
2. (9, 135, 70)
3. (24, 96, 25)
4. (12, 228, 105)

**Solution :**

The correct answer is **option 1** i.e. **(12, 108, 45)**.

The logic used here is:

$$(17, 136, 40)$$

$$136 \div 17 = 8$$

$$8 \times 5 = 40$$

$$(11, 198, 90)$$

$$198 \div 11 = 18$$

$$18 \times 5 = 90$$

Similarly,

$$(12, 108, 45)$$

$$108 \div 12 = 9$$

$$9 \times 5 = 45$$

Hence, **option 1** is the correct answer.

**Question 20 :**

A @ B means 'A is the sister of B'. A & B means 'A is the brother of B'. A # B means 'A is the wife of B'. A ^ B means 'A is the mother of B'. A + B means 'A is the father of B'. If Z & P + N ^ Q # S & V + E @ L, then which of the following statements is not correct?

Difficulty : Moderate

Average Time : 57 Seconds

**Options :**

1. V is the father of L.
2. Q is the mother of E.
3. P is maternal grandfather of Q.
4. N is mother-in-law of S.

**Solution :**

The correct answer is **option 2** i.e. **Q is the mother of E.**

In the diagram shown;

Square shows males, the circle shows females, vertical lines show generations, a single horizontal line shows brothers or sisters, and double lines show a couple.

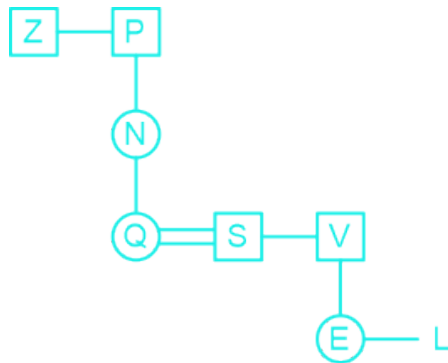

From the above tree, Q is not the mother of E.

Hence, **option 2** is the correct answer.

**Question 21 :**

Startup India was launched under the \_\_\_\_\_Ministry

Difficulty : Moderate

Average Time : 57 Seconds

**Options :**



Ministry of Skill Development and Entrepreneurship

2. Ministry of Social Justice and Empowerment

3. Ministry of Labour and Employment

4. Ministry of Commerce and Industry

### Solution :

The correct answer is **option 4 i.e. Ministry of Commerce and Industry.**

- The Startup India was launched under the **Ministry of Commerce and Industry.**
- Startup India is a flagship initiative launched by the Government of India on 16th January, 2016 to build a strong ecosystem for nurturing innovation and startups in the country which will drive economic growth and generate large scale employment opportunities.

### Question 22 :

It is used in making gunny bags, mats, ropes, yarn, carpets and other artefacts. Which crop is being spoken about here?

Difficulty : Moderate

Average Time : 55 Seconds

### Options :

1. jute
2. banana
3. coconut
4. palm

### Solution :

The correct answer is **option 1 i.e. jute.**

- **Jute** is a natural fibre cash crop just like cotton crop. It grows well in hot and moist climate.
- In India, the Ganga delta region is excellent for jute cultivation as this region has fertile alluvium soil and favorable temperature along with sufficient rainfall.
- Earlier, raw jute was used as raw material for packaging industries only, later it has emerged as a source for paper industries, textile industries, building and locomotive industries, soil saver, decorative and furnishing materials.

### Question 23 :

Who among the following has received Rajiv Gandhi Puraskar, Indira Priyadarshini Samman and Rotary International Award?

Difficulty : Moderate

Average Time : 55 Seconds



## Options :

1. N. Rajam
2. Mahaboob Subhani
3. Zia Mohiuddin Dagar
4. Shovana Narayan

## Solution :

The correct answer is **option 4 i.e. Shovana Narayan.**

- **Shovana Narayan** has been bestowed with various such as Rajiv Gandhi Puraskar, Indira Priyadarshini Samman, Rotary International Award, Japan's Oisca Award and the Padma Shri for her outstanding contribution to dance.
- Shovana Narayan is an exponent of Kathak, who believes in innovation along with a dedication to the strict classical disciplines of dance.

## Question 24 :

Which of the following is NOT related with the primary sector of economy?

Difficulty : Moderate

Average Time : 49 Seconds

## Options :

1. Forestry
2. Dairy
3. Fishing
4. Banking

## Solution :

The correct answer is **option 4 i.e. Banking.**

- **Banking** does not fall under primary sector. It comes under the tertiary sector. The tertiary sector covers a wide range of activities from commerce to administration, transport, financial and real estate activities, businesses and personal services, education, health and social work.
- The primary sector of the economy includes all those activities and industries that extract raw materials for other sectors of the economy.
- Primary sector is called agriculture and allied sector because most of the natural products we consume come from agriculture, dairy, forestry and fishing.

## Question 25 :

The intervention of the government whether to expand demand or reduce it constitutes the \_\_\_\_\_ function.



Difficulty : Moderate

Average Time : 57 Seconds

Options :

1. customisation
2. initiation
3. stabilisation
4. creation

Solution :

The correct answer is **option 3 i.e. stabilisation.**

- There may be times when demand exceeds available output under conditions of high employment and thus, may give rise to inflation. In such situations, restrictive conditions may be needed to reduce demand.
- The intervention of the government whether to expand, demand or reduce it constitutes the **stabilisation function.**
- Because the economy fluctuates, governments use fiscal or monetary policies to make sure that the economy is doing well.
- A stabilisation policy is a solution used by governments to mitigate unpredictable price fluctuations that harm an economy's GDP.

Question 26 :

Sattriya, is the classical dance form of which of the following states?

Difficulty : Moderate

Average Time : 56 Seconds

Options :

1. Tamil nadu
2. Uttar pradesh
3. Maharastra
4. Assam

Solution :

The correct answer is **option 4 i.e. Assam.**

- Sattriya, also known as Sattriya Nritya has its origin from Krishna in the state of **Assam.**
- Sattriya, 500 years old dance form is one of the major classical dances which comes from Vaishnavite monasteries of Assam.
- The dance form of Sattriya is a powerful medium of interpretation of faith associated with Vaishnavism.

**Question 27 :**

Which country has the longest written constitution in the world?

**Difficulty : Moderate**

**Average Time : 47 Seconds**

**Options :**

1. Netherlands
2. South Africa
3. United States of America
4. India

**Solution :**

The correct answer is **option 4** i.e. **India**.

- **India** has the longest written constitution in the world.
- The Constitution of India is the Supreme law of India. The document lays down the framework that demarcate fundamental political code, structure, procedures, powers and duties of government institutions and sets out fundamental rights, directive principles and the citizens, based on the proposal suggested by M.N Roy .
- It was adopted by the Constituent Assembly of India on 26 November, 1949 and became effective on 26 January, 1950.
- At present, Indian Constitution has 448 articles, 25 parts, 12 schedules and has made 105 amendments.

**Question 28 :**

What makes the imported goods more expensive?

**Difficulty : Moderate**

**Average Time : 57 Seconds**

**Options :**

1. Superior Quality
2. Custom Made goods
3. Tariffs
4. Rarity in nature

**Solution :**

The correct answer is **option 3** i.e. **Tariffs**.

- **Tariffs** makes the imported goods very expensive.
- A tariff is a type of tax levied by a country on an imported good at the border. Tariffs have historically been a tool for



governments to collect revenues, but they are also a way for governments to try to protect domestic producers.

- As a protectionist tool, a tariff increases the prices of imports. As a result, the consumers would choose to buy the relatively less expensive domestic goods instead.

**Question 29 :**

Which Shiv Sena leader from India was elected as Member of Rajya Sabha from Maharashtra in July 2022?

Difficulty : Moderate

Average Time : 57 Seconds

**Options :**

1. Sanjay Raut
2. Vinayak Raut
3. Uddhav Thackeray
4. Aaditya Thackeray

**Solution :**

The correct answer is **option 1 i.e. Sanjay Raut.**

- **Sanjay Raut**, a Shiv Sena leader from India was elected as Member of Rajya Sabha, the upper house of the Indian Parliament from Maharashtra in July 2022.
- He is the executive editor of Marathi newspaper Saamana, published by Udhav Thackeray, the Shiv Sena party leader.

**Question 30 :**

Which of the following is not a Cricketer?

Difficulty : Moderate

Average Time : 45 Seconds

**Options :**

1. Saina nehwal
2. Sachin Tendulkar
3. Javagal srinath
4. Rahul Dravid

**Solution :**

The correct answer is **option 1 i.e. Saina nehwal.**

- **Saina Nehwal** is not a cricketer. She is a first ever badminton player from India to clinch an Olympic medal.





She has represented India three times in the Olympics, winning a bronze medal in her second appearance at London 2022.

- On the other hand, Sachin Tendulkar, Javagal Srinath and Rahul Dravid are all associated with cricket.

**Question 31 :**

In which region did the Swadeshi Movement have the strongest impact on people?

Difficulty : Moderate

Average Time : 50 Seconds

**Options :**

1. Bengal
2. Kashmir
3. Berar
4. United Provinces

**Solution :**

The correct answer is **option 1 i.e. Bengal.**

- The Swadeshi Movement had the biggest impact in the region of **Bengal.**
- In August 1905, a huge meeting was held at the city of Calcutta Townhall, and the formal proclamation of the Swadeshi Movement was constructed there. It emancipated from the partition of Bengal.
- The message of the Swadeshi Movement was to avoid or boycott goods such as Manchester cloth and the salts of Liverpool, and to promote self sufficiency, contributing to Indian nationalism.

**Question 32 :**

In a badminton singles game, if both the players are on 29 points then at what point will one of them win the game?

Difficulty : Moderate

Average Time : 56 Seconds

**Options :**

1. 31st point
2. Match will be drawn
3. 30th point
4. 32nd point

**Solution :**

The correct answer is **option 3 i.e. 30th point.**



Below is a brief overview of the scoring system of badminton.

- A match consists of the best of 3 games of 21 points.
- Everytime there is a serve- there is a point scored.
- The side winning a rally adds a point to its score.
- At 20 all, the side which gains a 2 point lead first, wins the game.
- At 29 all, the side scoring the **30th point**, wins that game and
- The side winning a game serves first in the next game.

**Question 33 :**

The term of the Lok Sabha, unless dissolved is \_\_\_\_\_ from the date appointed for its first meeting.

**Difficulty : Moderate****Average Time : 61 Seconds****Options :**

1. 6 years
2. 5 years
3. 3 years
4. 4 years

**Solution :**

The correct answer is **option 2 i.e. 5 years.**

- The tenure of Lok Sabha is **5 years** from the date appointed for its first meeting.
- The President however, on the advice of the Council of Ministers, may dissolve it before the expiry of five years.
- In the case of national emergency, it's term can be extended for one year at a time. But it will not exceed six months after the emergency is over.

**Question 34 :**

What is the white precipitate formed in the reaction of sodium sulphate and barium chloride?

**Difficulty : Moderate****Average Time : 52 Seconds****Options :**

1. Barium hydroxide
2. Sodium chloride
3. Sodium oxide
4. Barium sulphate

**Solution :**

The correct answer is **option 4 i.e. Barium sulphate.**

- When barium chloride reacts with sodium sulphate, it forms white precipitate of **Barium sulphate**. A precipitate is an insoluble solid.
- Barium sulphate is the inorganic compound with the chemical formula  $\text{BaSO}_4$ . It is a white crystalline solid that is odorless and insoluble in water.

**Question 35 :**

Ravikirti composed prashasti of which of following Chalukya rulers?

Difficulty : Moderate

Average Time : 45 Seconds

**Options :**

1. Mangalesha I
2. Pulakeshin II
3. Kirtivaraman II
4. Vikramaditya IV

**Solution :**

The correct answer is **option 2 i.e. Pulakeshin II.**

- Ravikirti the court poet of **Pulakeshin II**, composed prashasti for Pulakeshin II.
- Pulakeshin II was the most famous ruler of the Chalukya dynasty who reigned from 610 to 642 CE.
- The Aihole Inscription, also known as the Aihole prashasti, is a nineteen line Sanskrit inscription at Meguti Jain temple I Aihole, Karnataka.
- It was an eulogy composed by the Jain poet Ravikirti in honor of his patron king Pulakeshin II of the Badami Chalukya dynasty.

**Question 36 :**

Loo is a characteristic feature of which season?

Difficulty : Moderate

Average Time : 54 Seconds

**Options :**

1. Summer
2. Winter
3. Spring

**Autumn****Solution :**

The correct answer is **option 1 i.e. Summer** .

- Loo is a strong, dusty hot and dry **summer** wind from the west that blows over North India and Pakistan's western Indo Gangetic plain and is extremely strong during the month of May and June.
- Due to extremely low humidity and high temperatures, the loo has a severe drying effect on vegetation, causing widespread browning in the areas affected.

**Question 37 :**

How many balanced meals of average size each day should adolescents have?

Difficulty : Moderate

Average Time : 49 Seconds

**Options :**

1. three
2. six
3. one
4. two

**Solution :**

The correct answer is **option 1 i.e. three** .

- Adolescents must have **three** well balanced meals of average size each day to meet the nutritional requirements of the body.
- Some of the healthy eating habits for adolescents are
- Eat 3 meals in a day, with healthy snacks in between
- Increase fibre in the diet
- Decrease the use of salt
- Drink enough water
- Choose fruit or vegetables for a snack
- Decrease the use of butter and heavy gravies and
- Consume more chicken and fish, limit red meat intake and choose lean cuts when possible

**Question 38 :**

As per the Census 2011, what was the literacy rate in India?

Difficulty : Moderate

Average Time : 59 Seconds



### Options :

1. 74.04%
2. 88.23%
3. 65.27%
4. 69.90%

### Solution :

The correct answer is **option 1 i.e. 74.04%**.

- The literacy rate in India is **74.04%** as per Census 2011.
- The results of 2011 census reveal that there has been an increase in literacy in the country.
- In the country's 74.04%, 82.14% were males and 65.46 were females. Kerala retained its position by being on the top with a 93.91% literacy rate, and followed by Lakshadweep with 92.28% and Mizoram with 91.58%.
- Bihar with a literacy rate of 63.82% ranks the last in the country, followed by Arunachal Pradesh with 66.95% and Rajasthan with 67.06%.

### Question 39 :

Buddha Purnima, celebrated by the devotees of Gautam Buddha, is known as Saga Dawa in which of the following states?

Difficulty : Moderate

Average Time : 55 Seconds

### Options :

1. Andhra pradesh
2. Maharashtra
3. Sikkim
4. Assam

### Solution :

The correct answer is **option 3 i.e. sikkim**.

- Buddha Purnima is also known as Saga Dawa in **Sikkim**.
- Saga Dawa is one of the most famous and biggest festivals of Sikkim and is celebrated with great enthusiasm and fervor every year.
- The festival is the most significant and sacred for the followers of Mahayana Buddhism who on this auspicious occasion commemorate Lord Buddha's birth, his attainment of Enlightenment and salvation from this corporeal world.

### Question 40 :



Who was appointed as the first female Director General of the Council of Scientific and Industrial Research (CSIR) in August 2022?

**Difficulty : Moderate**

**Average Time : 53 Seconds**

**Options :**

1. Navjit Kaur Brar
2. Apeksha Fernandes
3. Nallathamby Kalaiselvi
4. Savitri Jindal

**Solution :**

The correct answer is **option 3 i.e. Nallathamby Kalaiselvi.**

- Senior scientist, **Nallathamby Kalaiselvi** becomes the first female Director General of the Council of Scientific and Industrial Research (CSIR) in August 2022.
- Kalaiselvi hails from Ambasamudhram, Tirunelveli district of Tamil Nadu. She started her career in research as an entry-level scientist at CSIR.
- She has worked in research for 25 years and her research interests include lithium, supercapacitors and waste to wealth driven electrodes and electrolytes for energy storage device and electrocatalytic applications.

**Question 41 :**

The selling price of an article is  $(4/3)$  times of its cost price . The gain percentage is:

**Difficulty : Moderate**

**Average Time : 55 Seconds**

**Options :**

1.  $32(1/2)\%$
2.  $32(1/3)\%$
3.  $33(1/3)\%$
4.  $33(2/3)\%$

**Solution :**

The correct answer is **option 3 i.e.  $33(1/3)\%$ .**

Let us assume the cost price be =  $x$

Thus, the Selling Price would be =  $4x/3$



Thus Gain = Selling Price - Cost Price

$$= 4x/3 - x$$

$$= x/3$$

Thus the Gain is  $1/3$  or  $33\frac{1}{3}\%$  of the cost.

**Question 42 :**

The product of 2 numbers is 6750 and their LCM is 450. If the difference between the numbers is equal to their HCF, then find the smaller number.

Difficulty : Moderate

Average Time : 52 Seconds

**Options :**

1. 150
2. 75
3. 120
4. 90

**Solution :**

The correct answer is **option 2 i.e. 75**

As we know the

the product of the numbers = LCM  $\times$  HCF

$$6750 = 450 \times \text{HCF}$$

$$\text{HCF} = 15$$

Given, the difference between the numbers = HCF = 15

LCM of these numbers = 450 and product of numbers = 6750

The numbers should be uncommon factors of =  $450/15 = 30$

The pair of uncommon factors which satisfy the above criteria (5, 6)

Hence, the smallest number is =  $5 \times 15 = 75$

**Question 43 :**

X gets on a lift on the ground floor which goes up at a speed of 30 floors per minute whereas Y gets on another lift at the

same time on the 50th floor which goes down at a speed of 45 floors per minute. On which floor will their paths cross? (lifts are moving without stopping at any floor)

**Difficulty : Moderate**

**Average Time : 61 Seconds**

**Options :**

1. 18th
2. 25th
3. 24th
4. 20th

**Solution :**

The correct answer is **option 4 i.e. 20th**

Given that

X goes up from the ground floor at a speed of 30 floors per minute

Y goes down from the 50th floor at a speed of 45 floors per minute

Let, the time taken to cross each other be ' t ' minutes

According to the question

$$0 + 30t = 50 - 45t$$

$$75t = 50$$

$$t = 50/75 = 2/3 \text{ minutes}$$

$$\text{The number of floors covered by X in } 2/3 \text{ minutes} = 2/3 \times 30 = 20$$

$$\text{Hence, the floor at which they cross each other is} = 0 + 20 = 20\text{th}$$

**Question 44 :**

Two athletes A and B are running on a circular track of length 1800 m from the same starting point at the same starting time, at the speeds of 9 m/s and 6 m/s, respectively. At how many distinct points will they meet while running in opposite directions?

**Difficulty : Moderate**

**Average Time : 64 Seconds**

**Options :**

1. 15





3

3. 1

4. 5

**Solution :**

The correct answer is **option 4 i.e. 5**

Given that

A circular track of length 1800 m

Athlete A and B speeds are 9 m/s and 6 m/s, respectively.

If they run from the starting point in the opposite direction then they meet at the starting point again in = LCM of (1800/9, 1800/6) = LCM of (200, 300) = 600 sec

And they meet at any point if they are running in opposite directions from the starting point

= LCM of (1800/(9 + 6)) = LCM of (120) = 120 sec

Hence, They meet at = 600/120 = 5 distinct points while running in opposite direction

**Question 45 :**

Mehul buys a car for Rs. 560000. He renovates it and eventually sells it for Rs. 640000. The percent increase in the price of the car is:

Difficulty : Moderate

Average Time : 57 Seconds

**Options :**

1. 80/9 percent
2. 100/7 percent
3. 60/7 percent
4. 50/3 percent

**Solution :**

The correct answer is **option 2 i.e. 100/7 percent.**

The percentage increase in the price car is =  $\frac{\text{Selling Price} - \text{Cost Price}}{\text{Cost Price}} \times 100$

=  $(6,40,000 - 5,60,000)/5,60,000 \times 100$

=  $(80,000)/(5,60,000) \times 100$



=100/7 %

**Question 46 :**

If the length of the longest diagonal of a cube is 63 cm, then find the volume of the cube

**Difficulty : Moderate**

**Average Time : 42 Seconds**

**Options :**

1. 126 cm<sup>3</sup>
2. 612 cm<sup>3</sup>
3. 216 cm<sup>3</sup>
4. 261 cm<sup>3</sup>

**Solution :**

The correct answer is **option 3 i.e. 216 cm<sup>3</sup>**

We know that the longest diagonal of a cube is the line joining two distant vertices of opposite faces of the cube.

1200px-cube diagonals  
**HERE AC IS THE LONGEST DIAGONAL**

The diagonal of cube is  $= \sqrt[3]{s}$

Thus,

$$\sqrt[3]{s} = 6\sqrt[3]{s}$$

$$s = 6$$

Thus volume of cube  $= s^3$

Thus,

$$V = 6^3$$

$$V = 216 \text{ cm}^3$$

**Question 47 :**

The total amount after 3 quarters would be Rs.13,310. If the rate of interest is 40% per annum and compounding is performed quarterly, determine the present value (in Rs.).

**Difficulty : Moderate**

**Average Time : 68 Seconds**

**Options :**

13000

2. 11000

3. 10000

4. 9000

**Solution :**

The correct answer is **option 3 i.e. 10000**.

We know that the formula of compound interest is:-

$$= P \times (1 + r/n)^{nt}$$

$$13310 = P \times (1 + 40/400)^3$$

$$13310 = P \times (1.1)^3$$

$$13310 = P \times (1.331)$$

$$P = 10,000$$

**Question 48 :**

Akash travels the distance from his home to school in three equal parts on his bicycle at a speed of 5 km/h, 10 km/h and 15 km/h, respectively. What is the average speed of Akash going from his home to school?

**Difficulty : Moderate**

**Average Time : 49 Seconds**

**Options :**

1. 10 km/hr

2.  $9(1/11)$  km/hr

3.  $8(2/11)$  km/hr

4. 11 km/hr

**Solution :**

The correct answer is **option 3 i.e.  $8(2/11)$  km/hr**

If Akash travels the distance in three equal portions. Thus let us assume that he traveled D km at speeds of 5km/h, 10 km/h, and 15 km/h.

Thus the time taken in each section would be = D/5, D/10, and D/15.

(as time taken = distance/speed)

Thus, we know that average speed = Total Distance/Total Time Taken

Thus,

$$\text{Average Speed} = (D + D + D)/(D/5 + D/10 + D/15)$$

$$= 90/11$$

$$= 8\frac{2}{11} \text{ km/hr.}$$

**Question 49 :**

Rs.12,600 is divided among 15 labourers. There are 7 men, 3 women and 5 boys. If each woman receives three times as much as each boy, and each man receives seven times as much as each boy, the share of each woman is \_\_\_\_\_.

**Difficulty : Moderate****Average Time : 63 Seconds****Options :**

1. Rs 1800
2. Rs 1200
3. Rs 600
4. Rs 900

**Solution :**

The correct answer is **option 3 i.e. Rs 600**

Let us denote that money received by men as M, women as W and boy as B

From the question, we can infer that:-

$$7M + 3W + 5B = 12,600 \text{ ----- (i)}$$

But, another relation is also given in the question

It is given that each woman receives three times as much as each boy, and each man receives seven times as much as each boy.

$$\text{Thus } W = 3B, \text{ and } M = 7B$$

Thus putting these values in the equation--(i)

$$7(7B) + 3(3B) + 5B = 12,600$$

$$49B + 9B + 5B = 12,600$$

$$63B = 12,600$$



B = 200

Thus,

**Each Woman will receive 3B, i.e  $3(200) = 300$  units of money.**

**Question 50 :**

Find the compound interest on a sum of ₹1,50,000 at the rate of 6% per annum to be compounded half yearly at the end of 2 years. (Approximate to the nearest integer.)

Difficulty : Moderate

Average Time : 67 Seconds

**Options :**

1. ₹15,676
2. ₹15,978
3. ₹16,275
4. ₹16,933

**Solution :**

The correct answer is **option 3** i.e. ₹16,275

We know the formula for value after compound interest is =  $P \times (1 + R/n)^{nt}$

Thus Interest received = Principal After Interest - Principal

Thus, Principal After Interest =  $(50,000) \times (1 + \frac{6}{(2)(100)})^{(2)(2)}$

=  $(50,000) \times (1.03)^4$

~ 56,275

**Interest = 56,275 - 50,000 = 6,275**

**Question 51 :**

The marked price of a fan is 25% more than its cost price. If a discount of 12% is given on the marked price, then the gain per cent is:

Difficulty : Moderate

Average Time : 50 Seconds

**Options :**

1. 8%



9%

3. 7%

4. 10%

**Solution :**

The correct answer is **option 4 i.e.10%**

Let the Cost Price be:  $x$

$$\begin{aligned}\text{Thus The marked price is} &= x + 25\%x \\ &= 125x/100\end{aligned}$$

Thus Selling Price = Marked Price - discount

$$\begin{aligned}\text{S.P.} &= 125x/100 - (12\%)(125x/100) \\ &= 11x/10\end{aligned}$$

Thus Gain per unit is = Selling Price - Cost Price

$$= 11x/10 - x$$

$$= x/10$$

**Thus, 10% of cost is the gain over each unit sold.**

**Question 52 :**

If  $3:5 = x:75$ , then what is the value of  $x$ ?

Difficulty : Moderate

Average Time : 54 Seconds

**Options :**

1. 42

2. 45

3. 50

4. 30

**Solution :**

The correct answer is **option 2 i.e. 45.**

We are given with  $3 : 5 = x : 75$

We can write the ratio in the form:-

$$a : b = \frac{a}{b}$$

$$3 : 5 = \frac{3}{5}$$

Thus

$$\frac{3}{5} = \frac{x}{75}$$

$$x = \frac{(75)(3)}{5}$$

$$x = 45$$

**Thus, the value of x is 45.**

**Question 53 :**

Aarav and Durga together can do a piece of work in 33 days. They worked together for 15 days and then Aarav left the work and Durga alone finished the remaining work in 30 days. Find the number of days in which Aarav alone can do the total work.

**Difficulty : Moderate**

**Average Time : 59 Seconds**

**Options :**

1.  $145/2$  days
2.  $135/2$  days
3.  $155/2$  days
4.  $165/2$  days

**Solution :**

The correct answer is **option 4 i.e.  $165/2$  days.**

We know that **Efficiency = Work/Time.**

Thus, **Work = (Efficiency)(Time)**

Thus, let us denote the efficiency of Aarav as  $E_a$ , and the efficiency of Durga as  $E_d$ .

Thus according to the question:-

$$T = 33 \text{ days}$$

Let us denote the total work =  $W$ .

$$(E_a + E_d)(33) = W \text{ ----- (i)}$$

and,

$$(E_a + E_d)15 + (E_d)30 = W \text{ -----(ii)}$$

Thus comparing eq (i) and (ii)

$$(E_a + E_d)(33) = (E_a + E_d)15 + (E_d)30$$

$$3/2(E_a) = (E_d)$$

$$\text{Thus, } E_a(T^1) = W$$

Thus,

$$(E_a + E_d)33 = E_a(T^1) = W$$

$$T^1 = 165/2 \text{ Days}$$

**Question 54 :**

If a person buys 15 pencils for ₹12, and sells 12 pencils for ₹15, find the gain or loss percentage.

**Difficulty : Moderate**

**Average Time : 80 Seconds**

**Options :**

1. Gain of 65.25%
2. Loss of 56.25%
3. Gain of 56.25%
4. Loss of 56.52%

**Solution :**

The correct answer is **option 3 i.e. Gain of 56.25%**

If we have bought 15 pencils for Rs. 12, then the cost of one pencil for us is Rs. 0.80.

Thus we are selling 12 pencils for Rs. 15. Then, for us, the cost of 12 pencils would be:-

$$= (0.8)(12)$$

$$= \text{Rs } 9.6$$

$$\text{Thus, Cost Price} = \text{Rs. } 9.6$$

$$\text{And, Selling Price} = \text{Rs } 15$$

$$\text{Thus Profit Percentage} = \left( \frac{\text{Selling Price} - \text{Cost Price}}{\text{Cost Price}} \right) \times 100$$

$$= (15 - 9.6)/(9.6) \times 100$$





= 56.25%

**Question 55 :**

There is 16 percent discount on a dozen pairs of trousers marked at Rs. 5000. How many pair of trousers can be bought with Rs. 2100?

Difficulty : Moderate

Average Time : 57 Seconds

**Options :**

1. 5

2. 7

3. 4

4. 6

**Solution :**

The correct answer is **option 4 i.e. 6.**

Thus, according to the question, we know that 12 pairs of trousers are sold at Rs. 5000 with a 16% discount.

Thus we are selling 12 pairs of jeans at:-

$$5000 - (5000)(16\%)$$

Rs 4,200

Thus if 12 pairs cost Rs. 4,200, then 1 pair will cost:-

$$4,200/12$$

Rs.350

Thus each pair costs Rs, 350.

Thus if we pay Rs. 2,100 for this, then

$$\text{No. of pairs} = 2100/350$$

= 6

**Thus, the person will be able to buy 6 pairs in Rs.2,100.**

**Question 56 :**

A number is decreased from 200 to 150. Find the decrease percentage.

Difficulty : Moderate

Average Time : 54 Seconds

Options :

1. 25%
2. 51%
3. 43%
4. 32%

Solution :

The correct answer is **option 1 i.e. 25%**

The value is decreased from 200 to 150. Thus, we know:-

$$\frac{\{\text{Old value} - \text{New Value}\}}{\{\text{Old Value}\}} \times 100$$

$$(200 - 150)/(200) \times 100$$

$$50/200 \times 100$$

$$25\%$$

Question 57 :

A cylinder has a diameter of 14 cm, and its curved surface area is 220 cm<sup>2</sup> . The volume of the cylinder is:

Difficulty : Moderate

Average Time : 43 Seconds

Options :

1. 670cm<sup>2</sup>
2. 770cm<sup>2</sup>
3. 707cm<sup>2</sup>
4. 620cm<sup>2</sup>

Solution :

The correct answer is **option 2 i.e 770cm<sup>2</sup>**.

We know, that the curved surface area of cylinder is = 2rh

and Volume of Cylinder is = r<sup>2</sup>h

Thus we can write the volume as:-



$$rh \times r$$

$$2rh \times r/2$$

$$C.S.A \times r/2$$

We have diameter = 14cm

Thus, radius = 7cm

thus Volume = C.S.A  $\times$  7/2

$$(220)(7/2)$$

$$770$$

**Thus, the volume of the cylinder is 770 cm<sup>2</sup>.**

**Question 58 :**

A train is running at a speed of 129 km/h on a straight railway track, and a small car on a parallel road is running at a speed of 60 km/h. How long (in seconds, rounded off to the nearest integer) will the train take to cross the car completely if the train is 943 m long and they are running in the same direction? Ignore the length of the car as compared to the length of the train.

**Difficulty : Moderate**

**Average Time : 75 Seconds**

**Options :**

1. 49

2. 59

3. 39

4. 29

**Solution :**

The correct answer is **option 1 i.e. 49**

If the train is moving at a speed of 129 km/h and the car is moving at a speed of 60 km/h, then the net speed movement of the train beyond the car is = 129 - 60 = **69 km/h**.

To cross the car completely, the train has to cover its whole length by to take over the car.

Thus the length of train = 943 m or 0.943 km

Thus, Time taken by train to cover this length = Distance/Speed  
= 0.943/69

$$= 0.0136667 \text{ hours}$$

To convert it into seconds, we will multiply it by 3600 (as 1 hours = 3600 seconds)

$$= (0.0136667)(3600)$$
$$= 49.20012 \text{ seconds}$$

**Thus, the train will take 49 seconds (rounded off figure) to cross the car.**

**Question 59 :**

12 women and 16 men can do a piece of work in 11 days. If each woman takes twice the time taken by a man to do the work, in how many days will 16 men do the same work?

**Difficulty : Moderate**

**Average Time : 112 Seconds**

**Options :**

1.  $(117/8)$  days
2.  $(115/8)$  days
3.  $(125/8)$  days
4.  $(121/8)$  days

**Solution :**

The correct answer is **option is 4 i.e.  $(121/8)$  days.**

We know that **Efficiency = Work Done / Time**

Thus, let us denote Work done as "WD" and Time Taken as "T", Efficiency of Women as  $E_w$ , and Efficiency of Men as  $E_m$ .

Thus according to the question:-

$$E_w = WD/2T \text{ and } E_m = WD/T$$

$$2E_w = WD/T$$

$$2E_w = E_m \text{ ----- (i)}$$

and,

Time Taken by 12 women + Time Taken by 16 men = 11 days

Thus we can write  $E = WD/T$

Thus,  $WD = (E)(T)$

Thus,

$$[E(12 \text{ Women}) + E(16 \text{ Men})] (11 \text{ Days}) = W.D \text{ ----- (ii)}$$

Now, the Same amount of work done by only 16 men would be:-

$$E(16 \text{ Men}) = W.D/T^1 \quad (T^1 \text{ displays different amount of time required by only 16 men to complete the work})$$

we can write it as:-

$$W.D = [E(16 \text{ Men})](T^1) \text{----- (iii)}$$

Thus we can write equation (ii) as:-

$$[12E_w + 16E_m](11) = W.D$$

and Eq (iii) as:-

$$16E_m (T^1) = W.D$$

comparing eq (ii) and (iii)

$$[12E_w + 16E_m](11) = 16E_m (T^1)$$

From eq(i)

$$[12(E_m/2) + 16E_m](11) = 16E_m (T^1)$$

$$E_m [6 + 16](11) = 16E_m(T^1)$$

$$T^1 = 242/16$$

$$= 121/8 \text{ Days}$$

**Question 60 :**

Which of the given pairs form a co-prime numbers pair?

**Difficulty : Moderate**

**Average Time : 117 Seconds**

**Options :**

1. (21 , 42)
2. (9 , 63)
3. (36 , 15)
4. (11 , 21)

**Solution :**

The correct answer is **option 4 i.e. (11, 21)**



Since the other pairs have common factors other than 1 as:-

(21, 42) have 7 and 3 as other factors.

(9, 63) have 3 and another 3 as prime factors.

(36, 15) have 3, as common prime factors.

But in (11, 21) there are no other common factors other than 1.

Thus (11, 21) is the pair of co-prime numbers pair.

**Question 61 :**

Select the INCORRECTLY spelt word.

Difficulty : Moderate

Average Time : 42 Seconds

**Options :**

1. Grammar
2. Swindle
3. Kindergarten
4. Imaginery

**Solution :**

The correct answer is **option 4 i.e. Imaginery.**

- The correct spelling is **Imaginary.**

**Question 62 :**

Select the most appropriate option that can substitute the underlined segment in the given sentence. I still enjoyed the week despite of the weather.

Difficulty : Moderate

Average Time : 37 Seconds

**Options :**

1. despite with the weather
2. despite for the weather
3. despite to the weather
4. despite the weather

**Solution :**



The correct answer is **option 4 i.e. despite the weather.**

- Here, "**the weather**" is a noun that follows "**despite**" to indicate that the enjoyment of the week was not affected by the weather.

**Question 63 :**

Select the most appropriate meaning of the given idiom. An axe to grind

Difficulty : Moderate

Average Time : 44 Seconds

**Options :**

1. Personal and selfish reason
2. Extra effort for solving problems
3. Handling sharp items
4. To act justly

**Solution :**

The correct answer is **option 1 i.e. Personal and selfish reason.**

- The meaning of the idiom "**an axe to grind**" is "**personal and selfish reasons.**"
- This means having a secret and usually selfish reason for doing something or supporting a certain idea.

**Question 64 :**

Select the most appropriate option to fill in the blanks and make the sentence meaningful. My \_\_\_\_\_ gives me fresh coffee every \_\_\_\_\_.

Difficulty : Moderate

Average Time : 50 Seconds

**Options :**

1. made; morning
2. made; mourning
3. maid; mourning
4. maid; morning

**Solution :**



The correct answer is **option 4 i.e. maid; morning.**

- **Made** is the past tense and past participle of the verb "make." It indicates that something was created, formed, or produced.
- **Maid** refers to a female househelp who is responsible for cleaning, cooking, and other household tasks.
- **Morning** is the early part of the day, from dawn until noon.
- **Mourning** is a period of sadness and grief following a loss, especially the death of a loved one.
- **Hence, the correct answer would be "maid; morning."**

**Question 65 :**

Select the most appropriate synonym of the given word. Exciting

Difficulty : Moderate

Average Time : 62 Seconds

**Options :**

1. Dreary
2. Electrifying
3. Moral
4. Vengeful

**Solution :**

The correct answer is **option 2 i.e. Electrifying.**

- **Dreary** means dull, gloomy, or lacking interest.
- **Electrifying** refers to something that is extremely exciting or thrilling.
- **Moral** refers to principles of right and wrong behavior, ethics, or values.
- **Vengeful** describes a person who seeks revenge or desires to harm someone who has done something wrong with them.
- **Hence, the correct answer would be "Electrifying."**

**Question 66 :**

Select the most appropriate ANTONYM of the given word. Eager

Difficulty : Moderate

Average Time : 54 Seconds

**Options :**



Indifferent

2. Sharp
3. Great
4. Greedy

### Solution :

The correct answer is **option 1 i.e. Indifferent.**

- **Eager:** Having a strong desire or enthusiasm for something.
- **Indifferent:** Having a lack of interest, concern, or enthusiasm.
- **Sharp:** It can refer to being quick to understand or notice things.
- **Great:** It means something of considerable size, extent, or significance.
- **Greedy:** Having an excessive desire for wealth, possessions, or power.
- **Hence, the correct antonym for "eager" is "indifferent."**

### Question 67 :

Select the INCORRECTLY spelt word

Difficulty : Moderate

Average Time : 55 Seconds

### Options :

1. Argue
2. Lapse
3. Spoil
4. Blinc

### Solution :

The correct answer is **option 4 i.e. Blinc.**

- The correct spelling is "**Blink.**"

### Question 68 :

Select the most appropriate ANTONYM of the given word. Invincible

Difficulty : Moderate

Average Time : 33 Seconds



## Options :

1. Vulnerable
2. Powerful
3. Safe
4. Secure

## Solution :

The correct answer is **option 1 i.e. Vulnerable.**

- **Vulnerable** refers to a state of being easily harmed, injured, or attacked.
- **Powerful** means having great strength and capability.
- **Safe** describes a state of being free from risk.
- **Secure** implies being fixed or protected against unwanted changes or threats.
- Hence, the most appropriate antonym of "**invincible**" is "**vulnerable**."

## Question 69 :

Select the most appropriate option that can substitute the underlined segment in the given sentence. If there is no need to substitute it, select 'No substitution required'. The fire fighters were able to put out the fire in the industrial unit.

Difficulty : Moderate

Average Time : 65 Seconds

## Options :

1. to put off
2. putting out
3. No substitution required
4. putting off

## Solution :

The correct answer is **option 3 i.e. No substitution required.**

- The phrase "**to put out**" is the correct and idiomatic way to express the action of extinguishing a fire.
- This phrase means stopping or ending something.
- Hence, the correct answer would be "**No substitution required.**"

**Question 70 :**

Select the most appropriate option to fill in the blank. Differences among the various groups do not \_\_\_\_\_ well for the future of the peace treaty.

Difficulty : Moderate

Average Time : 50 Seconds

**Options :**

1. auger
2. ogre
3. oar
4. augur

**Solution :**

The correct answer is **option 4 i.e. augur.**

- The sentence would be: **Differences among the various groups do not augur well for the future of the peace treaty.**
- **Auger** is a tool used for boring holes in wood or the ground.
- **Ogre** is a mythical creature, typically depicted as a large and frightening monster.
- **Oar** is a long pole with a flat blade, used for rowing a boat.
- **Augur** means to be a sign or omen of a future event, often used in the context of making predictions or forecasts.
- Hence, the correct answer would be '**augur.**'

**Question 71 :**

Select the most appropriate option that can substitute the underlined segment in the given sentence. If there is no need to substitute it, select 'No substitution'. The District Collector, Mr Kaushalendra Kumar, are visiting the site for inspection.

Difficulty : Moderate

Average Time : 71 Seconds

**Options :**

1. No substitution
2. is visiting the site
3. is visiting cite
4. are visiting site

**Solution :**

Page No: 51

Follow us on



Address : 1997, Mukherjee Nagar, 110009

Email : [online@kdcampus.org](mailto:online@kdcampus.org)

Call : +91 95551 08888

Download the App





The correct answer is **option 2 i.e. is visiting the site.**

- The original sentence is incorrect due to a subject-verb agreement error.
- The subject "The District Collector, Mr. Kaushalendra Kumar" is **singular**, but the verb "are" is **plural**.
- **The correct verb should be singular to match the singular subject.**
- The sentence should be: **The District Collector, Mr. Kaushalendra Kumar, is visiting the site for inspection.**

### Question 72 :

Select the most appropriate meaning of the given idiom. Get the picture

Difficulty : Moderate

Average Time : 54 Seconds

### Options :

1. To control something
2. To understand what's happening
3. To buy something
4. To watch with own eyes

### Solution :

The correct answer is **option 2 i.e. To understand what's happening.**

- The idiom "**get the picture**" means to understand a situation or concept clearly.

### Question 73 :

Select the most appropriate synonym of the given word. Conquer

Difficulty : Moderate

Average Time : 41 Seconds

### Options :

1. Attach
2. Separate
3. Surrender
4. Defeat

### Solution :

The correct answer is **option 4 i.e. Defeat.**

- **Conquer:** To gain control over, or defeat someone or something through superior efforts.



**Attach:** To connect one thing to another. It can refer to joining objects physically or associating emotions.

- **Separate:** To disconnect two or more things that were together.
- **Surrender:** To give up to someone or something.
- **Defeat:** To win a victory over an opponent, rival, or obstacle.
- **Hence, the suitable synonym for "conquer" is "defeat."**

**Question 74 :**

Select the option that expresses the given sentence in past perfect tense. A. The participants practised a lot for play. B. The participants had practised a lot for play. C. The participants had been practising a lot for play. D. The participants were practising a lot for play.

Difficulty : Moderate

Average Time : 69 Seconds

**Options :**

1. C
2. A
3. B
4. D

**Solution :**

The correct answer is **option 3 i.e. B.**

- The past perfect tense is used to indicate that an action was completed before another action or event took place in the past.
- **"Had practised"** indicates that the practice occurred before the participants started to play.

**Question 75 :**

Select the most appropriate ANTONYM of the given word. Freedom

Difficulty : Moderate

Average Time : 42 Seconds

**Options :**

1. Bondage
2. Scarcity
3. Starvation

### Courage

#### Solution :

The correct answer is **option 1 i.e. Bondage.**

- **Freedom** refers to the state of being free, having the power to act or make choices without limitations.
- **Bondage** refers to a state of being bound or restrained. It involves restrictions on one's freedom.
- **Scarcity** means a shortage or lack of something.
- **Starvation** is a severe condition resulting from absence of food or inadequate nourishment.
- **Courage** is the ability to confront fear, pain, or danger.
- Hence, the correct answer would be "**Bondage.**"

#### Comprehension :

In the following passage, some words have been deleted. Read the passage carefully and select the most appropriate option to fill in each blank. Delhi National Zoological Park, which opened in 1959, is (1.) \_\_\_\_\_ next to the wellknown Old Fort. One of the top zoos in the entire Asian continent, it stands out for its (2.) \_\_\_\_\_ to give the animals and the birds housed there a habitat that is as close to natural as possible. With a total area of 214 acres, it is perfect for picnics, (3.) \_\_\_\_\_ in the winter. The National Zoological Gardens in New Delhi are home to over 2,000 different animal and bird (4.) \_\_\_\_\_. These animals and birds, which originate from many areas such as Africa, America, Australia, etc., (5.) \_\_\_\_\_ a home at this zoo. The Mughal Kos Minar serves as the Delhi Zoo's entrance.

#### Question 76 :

Select the most appropriate option to fill in blank number 1.

Difficulty : Moderate

Average Time : 97 Seconds

#### Options :

1. vacated
2. waited
3. located
4. queued

#### Solution :

The correct answer is **option 3 i.e. located.**



- Vacated** means that a place has been abandoned or emptied.
- **Waited** means to stay in one place for a period of time.
  - **Located** means to be situated in a particular place.
  - **Queued** refers to people or things waiting in a line.
  - In the context, the word "**located**" is used to describe where the zoo is situated, next to the Old Fort.
  - Hence, the correct answer would be "**located.**"

**Comprehension :**

In the following passage, some words have been deleted. Read the passage carefully and select the most appropriate option to fill in each blank. Delhi National Zoological Park, which opened in 1959, is (1.) \_\_\_\_\_ next to the wellknown Old Fort. One of the top zoos in the entire Asian continent, it stands out for its (2.) \_\_\_\_\_ to give the animals and the birds housed there a habitat that is as close to natural as possible. With a total area of 214 acres, it is perfect for picnics, (3.) \_\_\_\_\_ in the winter. The National Zoological Gardens in New Delhi are home to over 2,000 different animal and bird (4.) \_\_\_\_\_. These animals and birds, which originate from many areas such as Africa, America, Australia, etc., (5.) \_\_\_\_\_ a home at this zoo. The Mughal Kos Minar serves as the Delhi Zoo's entrance.

**Question 77 :**

Select the most appropriate option to fill in blank number 2.

Difficulty : Moderate

Average Time : 94 Seconds

**Options :**

1. effects
2. efforts
3. affects
4. escalations

**Solution :**

The correct answer is **option 2 i.e. efforts.**

- **Effects** refer to the results or outcomes of actions.
- **Efforts** refer to the actions or attempts made to achieve a particular goal.
- **Affects** is a verb that means to influence or have an impact on something.
- **Escalations** refer to the act of increasing or intensifying something.
- The sentence is discussing the zoo's dedication to providing a habitat close to nature for the animals, and the word



"efforts" conveys this dedication effectively.

- Hence, the correct answer would be "efforts."

### Comprehension :

In the following passage, some words have been deleted. Read the passage carefully and select the most appropriate option to fill in each blank. Delhi National Zoological Park, which opened in 1959, is (1.) \_\_\_\_\_ next to the wellknown Old Fort. One of the top zoos in the entire Asian continent, it stands out for its (2.) \_\_\_\_\_ to give the animals and the birds housed there a habitat that is as close to natural as possible. With a total area of 214 acres, it is perfect for picnics, (3.) \_\_\_\_\_ in the winter. The National Zoological Gardens in New Delhi are home to over 2,000 different animal and bird (4.) \_\_\_\_\_. These animals and birds, which originate from many areas such as Africa, America, Australia, etc., (5.) \_\_\_\_\_ a home at this zoo. The Mughal Kos Minar serves as the Delhi Zoo's entrance.

### Question 78 :

Select the most appropriate option to fill in blank number 3.

Difficulty : Moderate

Average Time : 98 Seconds

### Options :

1. **explicitly**
2. **especially**
3. **exactly**
4. **variable**

### Solution :

The correct answer is **option 2 i.e. especially**.

- The completed sentence is: **With a total area of 214 acres, it is perfect for picnics, especially in the winter.**
- The word emphasises on the idea that it's a great place for picnicking during the winter.
- The other options (**explicitly**, **exactly**, and **variable**) do not fit the context.

### Comprehension :



In the following passage, some words have been deleted. Read the passage carefully and select the most appropriate option to fill in each blank. Delhi National Zoological Park, which opened in 1959, is (1.) \_\_\_\_\_ next to the wellknown Old Fort. One of the top zoos in the entire Asian continent, it stands out for its (2.) \_\_\_\_\_ to give the animals and the birds housed there a habitat that is as close to natural as possible. With a total area of 214 acres, it is perfect for picnics, (3.) \_\_\_\_\_ in the winter. The National Zoological Gardens in New Delhi are home to over 2,000 different animal and bird (4.) \_\_\_\_\_. These animals and birds, which originate from many areas such as Africa, America, Australia, etc., (5.) \_\_\_\_\_ a home at this zoo. The Mughal Kos Minar serves as the Delhi Zoo's entrance.

**Question 79 :**

Select the most appropriate option to fill in blank number 4.

Difficulty : Moderate

Average Time : 87 Seconds

**Options :**

1. kingdoms
2. varieties
3. species
4. beings

**Solution :**

The correct answer is **option 3 i.e. species.**

- The sentence would be: **The National Zoological Gardens in New Delhi are home to over 2,000 different animal and bird species.**
- In this context, "**species**" is the term commonly used to refer to different types of animals and birds, so it is the suitable choice.

**Comprehension :**

In the following passage, some words have been deleted. Read the passage carefully and select the most appropriate option to fill in each blank. Delhi National Zoological Park, which opened in 1959, is (1.) \_\_\_\_\_ next to the wellknown Old Fort. One of the top zoos in the entire Asian continent, it stands out for its (2.) \_\_\_\_\_ to give the animals and the birds housed there a habitat that is as close to natural as possible. With a total area of 214 acres, it is perfect for picnics, (3.) \_\_\_\_\_ in the winter. The National Zoological Gardens in New Delhi are home to over 2,000 different animal and bird (4.) \_\_\_\_\_. These animals and birds, which originate from many areas such as Africa, America, Australia, etc., (5.) \_\_\_\_\_ a home at this zoo. The Mughal Kos Minar serves as the Delhi Zoo's entrance.

**Question 80 :**

Select the most appropriate option to fill in blank number 5.

Difficulty : Moderate

Average Time : 80 Seconds

Options :

1. finding
2. find
3. found
4. finds

Solution :

The correct answer is **option 2 i.e. find.**

- The sentence should be: **These animals and birds, which originate from many areas such as Africa, America, Australia, etc., find a home at this zoo.**
- In this context, the correct answer should be "find" in its present tense form.
- The sentence is discussing the current status of these animals and birds at the zoo. It means that they have their home at the zoo.

## Ssc Gd Constable Tier I Previous Year Question Paper Analysis

The analysis of Ssc Gd Constable Tier I Previous Year Question Paper held on 2023-01-12 in the Morning exam is as follows:

1. 80 questions were moderate.
2. The safe score is 120 marks.
3. , 20 questions were asked from Logical Reasoning, 20 questions were asked from General Awareness, 20 questions were asked from Quantitative Aptitude and 20 questions were asked from English Language
4. 5 questions should have been skipped if you were short of time.

## Ssc Gd Constable Tier I Previous Year Question Paper Topic Wise Weightage

### Logical Reasoning

1. Coding Decoding - 2
2. Analogy - 3

Page No: 58

Follow us on



Address : 1997, Mukherjee Nagar, 110009

Email : [online@kdcampus.org](mailto:online@kdcampus.org)

Call : +91 95551 08888

Download the App





- Seating Arrangement - 1
- 4. Blood Relations - 1
- 5. Syllogism - 1
- 6. Dictionary Based - 1
- 7. Figure Based - 3
- 8. Series - 4
- 9. Mathematical Reasoning - 2
- 10. Seating Arrangement And Puzzle - 2

## General Awareness

- 1. Art And Culture - 20

## Quantitative Aptitude

- 1. Arithmetic - 20

## English Language

- 1. Reading Comprehension - 5
- 2. Grammar - 1
- 3. Idioms - 2
- 4. Fillers - 1
- 5. Sentence Improvement - 3
- 6. Synonym - 2
- 7. Antonym - 3
- 8. Filler (Vocab) - 1
- 9. Incorrectly Spelt - 2
- 10. Incorrectly Spelt - 2

# Ssc Gd Constable Tier I Previous Year Question Paper Tips and Tricks



1. Try to solve Ssc Gd Constable Tier I Previous Year Question Paper without taking any help from the solutions.
2. Ssc Gd Constable Tier I Previous Year Question Paper require proper usage of concept so firstly read the question thoroughly and then use the right concept.
3. In case you're not able to solve the question in less than 30 seconds in the exam then you should skip the question and move to the next question.

## Daily Current Affairs



KD Live is providing [Current Affairs](#) on a daily basis for SSC and a [Current Affairs Quiz](#) too for the practice.

## KD Live Free Offerings



**5 LAKH+ STUDENTS**  
Already enrolled with our selection focused courses.



**30+ EXPERT INSTRUCTORS**  
Our instructors are the best in the industry



**10000+ HOURS OF VIDEOS**  
All videos are well-explained for you to get every bit out of the videos



KD Live is Offering Every Information and Study Material required for the self study. Please click on the following links for accessing those.

- [Study Plan](#)
- [General Science](#)
- [General Awareness](#)
- [General Knowledge](#)
- [Quantitative Aptitude](#)
- [Logical Reasoning](#)
- [English Language](#)
- [Today In History](#)
- [Syllabus](#)
- [Know Your State](#)
- [Know Your Country](#)
- [Know Your City](#)
- [Know Your Leader](#)
- [Books And Authors](#)
- [Daily Vocabulary](#)
- [Daily Editorial](#)
- [Latest Notifications](#)
- [Exam Dates](#)
- [Admit Card](#)
- [Exam Results](#)
- [Exam Cutoff](#)
- [Exam Eligibility](#)
- [Exam Pattern](#)





[Answer Key](#)  
[Important Days](#)  
[Full Form](#)  
[Previous Year PDF](#)

## Further Guidance on Ssc Gd Constable Tier I Previous Year Question Paper

For Asking any query on Ssc Gd Constable Tier I Previous Year Question Paper please mail [Send Email](#) or you can fill the form at [KD Live](#).

### About KD Live

KD live has an expertise in providing apt explanations for the Ssc Gd Constable Tier I Previous Year Question Paper since 2008. More than 10 lakh aspirants have cleared competitive exams under the guidance of Neetu Mam.

Study.kdcampus.live is providing free information on various topics and for the Ssc Gd Constable Exam you can refer the following link [Click Here](#) however if you want to practice more questions then please refer the following link [Click Here](#).

### About Neetu Mam

Neetu Mam is primarily passionate for the English language and teaching from the last 20 years however for the Ssc Gd Constable Tier I Previous Year Question Paper. She has guided her team to provide the best explanation for the question.