

# Ssc Cgl Tier I Previous Year Question Paper Overview

Here, you can solve all the questions asked in Ssc Cgl Tier I Previous Year Question Paper on 2022-04-20 in the Evening exam. The detailed solutions are also provided for every previous year question and some of these questions can be asked again in your Ssc Cgl Tier I exam. There are 100 questions in the exam and 60 minutes are provided for the Ssc Cgl Tier I exam. The Cutoff of the exam was 140 marks hence you should try to score at least 150 marks.

## Ssc Cgl Tier I Previous Year Question Paper : Questions and Solutions

### Question 1 :

Select the option that expresses the given sentence in direct speech. She exclaimed with sorrow that life had become miserable.

Difficulty : Moderate

Average Time : 44 Seconds

### Options :

1. She said, "How miserable had become life!"
2. She said, "Oh! What miserable life has become."
3. She said, "Life has become miserable."
4. She said, "Alas! How miserable life has become."

### Solution :

The correct answer is **option 4** i.e. **She said, "Alas! How miserable life has become."**

- The given sentence is an example of an Exclamatory sentence.
- The notion of reported speech changes the reporting verb.
- Exclamatory words are used at the start of a direct speech.
- 'Had' will change into 'has'.
- **That** is replaced using "**inverted commas**".
- Exclaimed with sorrow will be replaced by said.
- According to the assertive sentences, tense, pronoun, and adverbials are changed.

The correct sentence is:

She said, "Alas! How miserable life has become."

**Question 2 :**

The value of is:

**Difficulty : Moderate**

**Average Time : 68 Seconds**

**Options :**

1. -2
2. 3
3. 2
4. -3

**Solution :**

The correct answer is **option 1** i.e. -2

$$\cos^2 28^\circ = \sin^2(90 - 62)^\circ = \sin^2 62^\circ$$

$$\sin^2 55^\circ = \cos^2(90 - 35)^\circ = \cos^2 35^\circ$$

$$\frac{5 \cos^2 62^\circ + 5 \cos^2 28^\circ - 21}{7 \sin^2 35^\circ + 7 \sin^2 55^\circ + 1} = \frac{(5 \cos^2 62^\circ + 5 \sin^2 62^\circ - 21)}{(7 \sin^2 35^\circ + 7 \cos^2 35^\circ + 1)}$$

$$[5 \times (\cos^2 62^\circ + \sin^2 62^\circ) - 21] / [7 \times (\sin^2 35^\circ + \cos^2 35^\circ) + 1]$$

We know,  $\sin^2 x + \cos^2 x = 1$ . Thus,

$$(5 - 21) / (7 + 1) = -16/8 = -2$$

**Question 3 :**

Select the option in which the given figure is embedded (rotation is NOT allowed)

**Difficulty : Moderate**

**Average Time : 60 Seconds**

**Options :**

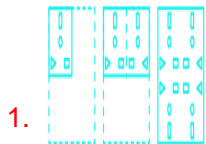

2.

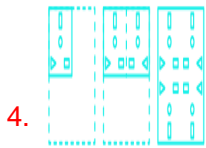
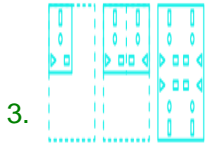
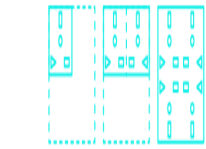

**Solution :**

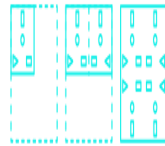

The correct answer is **option 3** i.e.

The given figure is embedded in option 3, as shown below:

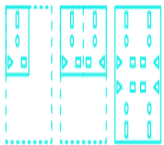

**Question 4 :**

Select the most appropriate meaning of the given idiom. Back out

**Difficulty :** Moderate

**Average Time :** 68 Seconds

**Options :**

1. To enquire
2. To throw
3. To explode
4. To withdraw

**Solution :**



The correct answer is **option 4** i.e. **To withdraw**

- The meaning of the given idiom is to **withdraw from a commitment**.
- Thus, option 4 would be the most appropriate choice among the given options.

**Question 5 :**

The following sentence has been divided into parts. One of them may contain a grammatical error. Select the part that contains the error from the given options. If you don't find any error, mark 'No error' as your answer. They had hardly completed / half of the work / than the boss called them.

Difficulty : Moderate

Average Time : 53 Seconds

**Options :**

1. than the boss called them
2. No error
3. half of the work
4. They had hardly completed

**Solution :**

The correct answer is **option 1** i.e. **than the boss called them**

- The error lies in the third part of the given sentence.
- **'Hardly/scarcely'** is always followed by **'when'**.
- Thus, 'than the boss called them' will be replaced by 'when the boss called them.'

**The correct sentence:**

*They had hardly completed half of the work **when** the boss called them.*

**Question 6 :**

Select the correct passive voice of the given sentence. Hold the rope firmly.

Difficulty : Moderate

Average Time : 53 Seconds

**Options :**

1. Let the rope be hold firmly.
2. Let the rope hold you firmly.
3. Let the rope be held firmly.

Let the rope firmly hold you.

**Solution :**

The correct answer is **option 3** i.e. **Let the rope be held firmly.**

- The given sentence is an example of **an imperative sentence.**
- So while converting the sentence, the structure of the given sentence will be **Let + Sub+ be + V3.**
- Since the passive form of the sentence is **a command, let** will be added at the start of the sentence.
- Hold should be changed into held.

**The correct passive form of the given sentence is:**

*Let the rope be held firmly.*

**Comprehension :**

Directions: In the following passage, some words have been deleted. Read the passage carefully and select the most appropriate option to fill in each blank. For an average Indian, driving in any of the major Indian cities is equivalent to (1) \_\_\_\_\_ a daily war. The everyday struggle of (2) \_\_\_\_\_ traffic, pollution, and rash drivers are (3) \_\_\_\_\_ biggest cause of chronic stress and other (4) \_\_\_\_\_ problems. On average a person spends (5) \_\_\_\_\_ between thirty minutes to two hours of their day driving.

**Question 7 :**

Select the most appropriate option to fill in blank no.3.

Difficulty : Moderate

Average Time : 84 Seconds

**Options :**

1. an
2. the
3. one
4. a

**Solution :**

The correct answer is **option 2** i.e. **the.**

- Whenever we have to describe a specific noun, we use the article **'the.'**
- Article **'the'** is used before both singular and plural nouns when it is specific.
- Articles **'a'** and **'an'** are used to describe a more general noun.

**The correct sentence is:**



....and rash drivers are **the** biggest cause of chronic stress and other....

### Question 8 :

When was the Tenth Session of the Constituent Assembly held?

Difficulty : Moderate

Average Time : 54 Seconds

### Options :

1. 16 May - 16 June 1949
2. 14-31 July 1947
3. 4 November 1948 - 8 January 1949
4. 6-17 October 1949

### Solution :

The correct answer is **option 4** i.e. **6-17 October, 1949**

- The tenth session of the Constituent Assembly was held from **6-17 October, 1949**.
- There were 11 sessions of the Constituent assembly.
- First Session: 9-23 December, 1946
- Second Session: 20-25 January, 1947
- Third Session: 28 April-2 May, 1947
- Fourth Session: 14-31 July, 1947
- Fifth Session: 14-30 August, 1947
- Sixth Session: 27 January, 1948
- Seventh Session: 4 November, 1948-8 January, 1949
- Eighth Session: 16 May-16 June, 1949
- Ninth Session: 30 July-18 September, 1949
- Tenth Session: **6-17 October, 1949**
- Eleventh Session: 14-26 November, 1949

The Assembly met once again on 24 January, 1950, when the members appended their signatures to the Constitution of India.

**Question 9 :**

\_\_\_\_\_ is a mask dance popular in South Malabar.

**Difficulty : Moderate****Average Time : 69 Seconds****Options :**

1. Kummattikali
2. Parichakali
3. Dhangar
4. Zemmado

**Solution :**

The correct answer is **option 1** i.e. **Kummattikali**.

- **Kummattikali** is a colourful mask-dance of Kerala, prevalent in Thrissur District, Palakkad District, and parts of South Malabar.
- It is performed during the festival of Onam, where the performers move from house to house entertaining people.
- The original form of **Kummattikali** can be seen in the Bhadrakali temple of Palghat district.

**Question 10 :**

Which of the following is a property of Beryllium?

**Difficulty : Moderate****Average Time : 47 Seconds****Options :**

1. Forms covalent compounds
2. Has a low melting and boiling point
3. Reacts with water
4. Forms ionic compounds

**Solution :**

The correct answer is **option 1** i.e. **Forms covalent compounds**

- Beryllium is an element with an atomic number of 4 in the periodic table. It is a bivalent and highly toxic element.
- Beryllium exists in 30 different minerals, among which bertrandite, beryl, chrysoberyl, and phenacite are the most



important.

- **Compounds** of beryllium are mostly **covalent** because of the high positive charge density on  $\text{Be}^{2+}$  ion and polarising power.

**Question 11 :**

Which of the following Mauryan rulers did Seleucus fight against in the Seleucid–Mauryan War?

**Difficulty :** Moderate

**Average Time :** 53 Seconds

**Options :**

1. Dasharatha
2. Ashoka
3. Samprati
4. Chandragupta Maurya

**Solution :**

The correct answer is **option 4** i.e. **Chandragupta Maurya**.

- The Seleucid-Mauryan War was fought between 305 and 303 BC.
- It was fought between Seleucus and **Chandragupta Maurya**.
- The war ended in a settlement resulting in the annexation of the Indus Valley region and part of Afghanistan to the Mauryan Empire, with Chandragupta securing control over the areas that he had sought, and a marriage alliance between the two powers.
- After the war, the Mauryan Empire emerged as the dominant power of the Indian subcontinent, and the Seleucid Empire turned its attention toward defeating its rivals in the West.

**Question 12 :**

Who among the following got the award for 'Best Supporting Actress' at the National Awards 2021?

**Difficulty :** Moderate

**Average Time :** 59 Seconds

**Options :**

1. Konkona Sen Sharma
2. Pallavi Joshi
3. Tisca Chopra
4. Divya Dutta

**Solution :**





The correct answer is **option 2** i.e. **Pallavi Joshi**

- **Pallavi Joshi** got the award for 'Best Supporting Actress' at the National Awards 2021 in her role in **The Tashkent Files**.
- The National Film Awards was distributed on October 25, 2021, by the Vice President of India, Shri. M Venkaiyanaidu.

**Question 13 :**

Who among the following was the recipient of the 'Vatayan Lifetime Achievement Award 2020'?

Difficulty : Moderate

Average Time : 47 Seconds

**Options :**

1. Prakash Javadekar
2. Ramesh Pokhriyal
3. Ravi Shankar Prasad
4. Piyush Goyal

**Solution :**

The correct answer is **option 2** i.e. **Ramesh Pokhriyal**

- **Ramesh Pokhriyal** was the recipient of the Vatayan Lifetime Achievement Award 2020.
- He was given the award for his excellent contribution to the literary works of India.
- He has written more than 75 books on varied fields. And many of his books have also been translated into many national and foreign languages.

**Question 14 :**

At which of the following jails was Khudiram Bose sent to the gallows?

Difficulty : Moderate

Average Time : 49 Seconds

**Options :**

1. Alipore
2. Muzaffarpur
3. Barishal
4. Chittagong

**Solution :**



The correct answer is **option 2** i.e. **Muzaffarpur**

- Khudiram Bose was sent to **Muzaffarpur jail** for his role in the attempted assassination of the Chief Presidency Magistrate DH Kingsford of Muzaffarpur.
- He was an Indian revolutionary from Bengal Presidency who opposed British rule of India.
- He was sentenced to death and subsequently executed, making him one of the youngest martyrs of the Indian Independence Movement.

**Question 15 :**

River Ken is one of the major rivers of the Bundelkhand region of central India and flows through two states, Madhya Pradesh and \_\_\_\_\_.

Difficulty : Moderate

Average Time : 51 Seconds

**Options :**

1. Rajasthan
2. Uttar Pradesh
3. Maharashtra
4. Gujarat

**Solution :**

The correct answer is **option 2** i.e. **Uttar Pradesh**

- River Ken is one of the major rivers of the Bundelkhand region of central India and flows through two states, Madhya Pradesh and **Uttar Pradesh**.
- It is a tributary of the **Yamuna**.
- Ken has an overall drainage basin of 28,058 km<sup>2</sup>, out of which 12,620 km<sup>2</sup> belong to **Sonar River** its largest tributary, whose entire basin lies in Madhya Pradesh; and along its 427 kilometres (265 mi) course it receives water from its own tributaries such as Bawas, Dewar, Kaith and Bains on the left bank, and Kopra and Bearma of the right.
- Out of its total length of 427 kilometres (265 mi) it flows for 292 kilometres (181 mi) in Madhya Pradesh, 84 kilometres (52 mi) in **Uttar Pradesh**, and 51 kilometres (32 mi) forms the boundary between the two states.

**Question 16 :**

Which of the following Amendments of the Constitution of India amended Article 19 and inserted provisions fully securing the constitutional validity of zamindari abolition laws in general and certain specified State Acts in particular?

Difficulty : Moderate

Average Time : 76 Seconds



## Options :

1. Third Amendment
2. Fourth Amendment
3. Second Amendment
4. First Amendment

## Solution :

The correct answer is **option 4** i.e. **First Amendment**

- The **First Amendment** of the Constitution of India amended Article 19 and inserted provisions fully securing the constitutional validity of zamindari abolition laws in general and certain specified State Acts in particular.
- The **First Amendment** was passed in 1951 by the Provisional Parliament, which was elected on a limited franchise.
- The First Amendment Act amended articles 15, 19, 85, 87, 174, 176, 341, 342, 372 and 376.
- It inserted articles 31A and 31B.
- It inserted Ninth Schedule to the Constitution to protect the land reform and other laws present in it from the judicial review.
- First Amendment Act had set the precedent of amending the Constitution to overcome judicial pronouncements to implement the programmes and policies of the Government.
- It placed reasonable restrictions on fundamental rights and added three more grounds of restrictions on freedom of speech such as public order, friendly relations with foreign states and incitement to an offence.

## Question 17 :

As per the Union Budget 2021-22, Mission Poshan 2.0 is proposed to be launched to improve nutritional outcomes across \_\_\_\_\_ aspirational districts.

Difficulty : Moderate

Average Time : 81 Seconds

## Options :

1. 101
2. 112
3. 119
4. 95

## Solution :

Page No: 11

Follow us on



Address : 1997, Mukherjee Nagar, 110009

Email : [online@kdcampus.org](mailto:online@kdcampus.org)

Call : +91 95551 08888

Download the App





The correct answer is **option 2** i.e. **112**

- As per the Union Budget 2021-22, Mission Poshan 2.0 is proposed to be launched to improve nutritional outcomes across **112** aspirational districts.
- The supplementary nutrition programme and the Poshan Abhiyaan has been merged to launch Mission Poshan 2.0 to strengthen nutritional content, delivery, outreach, and outcome.
- Poshan 2.0 scheme is an umbrella scheme covering the Integrated Child Development Services (ICDS), Anganwadi Services, Poshan Abhiyaan, Scheme For Adolescent Girls, National Creche Scheme).

**Question 18 :**

As per Economic Survey 2020-2021, during the first half of the financial year 2020-21, the services sector contracted by almost \_\_\_\_\_.

Difficulty : Moderate

Average Time : 53 Seconds

**Options :**

1. 6%
2. 21%
3. 16%
4. 11%

**Solution :**

The correct answer is **option 3** i.e. **16%**

- As per Economic Survey 2020-2021, during the first half of the financial year 2020-21, the services sector contracted by almost **16%**.
- The year 2020 was a peculiar year marred by the COVID-19 pandemic and consequent nationwide and worldwide lockdown measures implemented since March, 2020. The contact intensive services sector was severely impacted, particularly sub-sectors such as tourism, aviation, and hospitality.

**Question 19 :**

Which amendment to the Constitution of India added a new subject in the Union List called 'taxes on services'?

Difficulty : Moderate

Average Time : 50 Seconds

**Options :**

1. 88th



62nd

3. 56th

4. 78th

**Solution :**

The correct answer is **option 1** i.e. **88th**

- The **88th amendment** of the Constitution of India added a new subject in the Union List called 'taxes on services'.
- The government of India shall impose service taxes, which will be appropriated and then collected by the Indian government and the states.
- The profits of any such tax charged in line with the provisions of section in any financial year shall be collected and allocated by the Indian government and states.

**Question 20 :**

\_\_\_\_\_ develops on crystalline igneous rocks in areas of low rainfall in the eastern and southern part of the Deccan Plateau.

**Difficulty : Moderate**

**Average Time : 55 Seconds**

**Options :**

1. Alluvial soil
2. Arid soil
3. Black soil
4. Red soil

**Solution :**

The correct answer is **option 4** i.e. **Red soil**

- **Red soil** develops on crystalline igneous rocks in areas of low rainfall in the eastern and southern part of the Deccan Plateau.
- The soil develops a reddish colour due to a wide diffusion of iron in crystalline and metamorphic rocks. It looks yellow when it occurs in a hydrated form.
- The fine-grained red and yellow soils are normally fertile, whereas coarse-grained soils found in dry upland areas are poor in fertility. They are generally poor in nitrogen, phosphorus and humus.

**Question 21 :**

Which of the following countries will host the 2023 AIBA Men's World Boxing Championships?



Difficulty : Moderate

Average Time : 56 Seconds

Options :

1. Russia
2. Uzbekistan
3. Mongolia
4. Serbia

Solution :

The correct answer is **option 2** i.e. **Uzbekistan**

- **Uzbekistan** will host the 2023 AIBA Men's World Boxing Championships.
- The IBA World Boxing Championships, and the IBA Women's World Boxing Championships (previously known as AIBA), are biennial amateur boxing competitions organised by the International Boxing Association (IBA), which is the sport governing body.
- Alongside the Olympic boxing programme, they are the highest level of competition for the sport. The championships were first held for men in 1974 and the first women's championships were held in 2001.

Question 22 :

Who among the following was the Chief Justice of India – designate in April 2021?

Difficulty : Moderate

Average Time : 54 Seconds

Options :

1. Justice Arun Mishra
2. Justice NV Ramana
3. Justice Ashok Bhushan
4. Justice AM Khanwilkar

Solution :

The correct answer is **option 2** i.e. **Justice NV Ramana**

- **Justice N V Ramana**, was appointed the Chief Justice of India in april 2021. He assumed charge as the **48th** CJI on **April 24**, a day after the retirement of incumbent CJI Sharad Arvind Bobde.
- The Union law ministry requested CJI Bobde to recommend his successor in accordance with the memorandum of procedure (MoP) for the appointment of the judges in the Supreme Court
- As per the MoP, the senior-most judge of the Supreme Court of India, considered fit to hold the office of the Chief

Justice of India, should be appointed to the position.

**Question 23 :**

The following sentence has been split into four segments. Identify the segment that contains a grammatical error. We bought / two dozens / mangoes from / the market.

Difficulty : Moderate

Average Time : 67 Seconds

**Options :**

1. the market
2. We bought
3. mangoes from
4. two dozens

**Solution :**

The correct answer is **option 4** i.e. **two dozens**

- The error lies in the second part of the sentence.
- Instead of 'two dozens,' we should use 'two dozen.'
- We never write 'dozens' after using a numerical value ahead of it.

**Thus, the correct sentence is:**

*We bought two **dozen** mangoes from the market.*

**Question 24 :**

Select the option that can be used as a one-word substitute for the given group of words. Lacking interest or excitement

Difficulty : Moderate

Average Time : 51 Seconds

**Options :**

1. Mundane
2. Miserly
3. Despot
4. Hostile

**Solution :**

The correct answer is **option 1** i.e. **Mundane**



The meaning of the given words is:

- **Mundane:** not exciting or interesting.
- **Miserly:** characteristic of a miser
- **Despot:** a ruler with great power
- **Hostile:** harsh feeling against someone

The most appropriate one word substitute for the given set of words is **Mundane**.

**Question 25 :**

Select the most appropriate synonym of the given word. Ravenous

Difficulty : Moderate

Average Time : 50 Seconds

Options :

1. Starved
2. Content
3. Satiated
4. Full

**Solution :**

The correct answer is **option 1** i.e. **Starved**

The meaning of the given words is:

- **Ravenous:** extremely hungry.
- **Starved:** suffer or die or cause to suffer or die from hunger.
- **Content:** in a state of peaceful happiness.
- **Satiated:** another term for sate.
- **Full:** having no empty space.

Thus, the most appropriate synonym for 'Ravenous' is 'starved'.





## Question 26 :

Select the option that can be used as a one-word substitute for the given group of words. Place where objects of importance are exhibited

Difficulty : Moderate

Average Time : 59 Seconds

### Options :

1. Museum
2. Treasury
3. Fair
4. Exhibition

### Solution :

The correct answer is **option 1** i.e. **Museum**

### The meaning of the given words is:

- **Museum:** a building in which objects of historical, scientific, artistic, or cultural interest are stored and exhibited.
- **Treasury:** the funds or revenue of a state, institution, or society.
- **Fair:** treating people equally without favoritism or discrimination.
- **Exhibition:** a display or demonstration of a skill.

Thus, the most appropriate one-word substitution for the given set of words is **Museum**.

## Question 27 :

Select the INCORRECTLY spelt word.

Difficulty : Moderate

Average Time : 55 Seconds

### Options :

1. Syndicate
2. Contemplate
3. Temprate
4. Cooperate

### Solution :

Page No: 17

Follow us on



Address : 1997, Mukherjee Nagar, 110009

Email : [online@kdcampus.org](mailto:online@kdcampus.org)

Call : +91 95551 08888

Download the App





The correct answer is **option 3** i.e. **Temprate**

The meaning and correct spelling of the given words is:

- **Syndicate:** a group of individuals or organizations combined to promote a common interest.
- **Contemplate:** look thoughtfully for a long time at.
- **Temperate:** showing moderation or self-restraint.
- **Cooperate:** work jointly towards the same end.

**Question 28 :**

Select the most appropriate ANTONYM of the given word. Obdurate

Difficulty : Moderate

Average Time : 51 Seconds

Options :

1. Amenable
2. Rigid
3. Callous
4. Secure

**Solution :**

The correct answer is **option 1** i.e. **Amenable**

The meaning of the given words is:

- **Obdurate:** Refusing to change your mind.
- **Amenable:** Happy to accept something.
- **Rigid:** Not wanting to change.
- **Callous:** Not caring about the suffering of other people.
- **Secure:** Confident.

*The most appropriate antonym of **Obdurate** is **Amenable**.*

**Question 29 :**

The following sentence has been split into four segments. Identify the segment that contains a grammatical error. My friend / who's leg / was fractured / has recovered.



Difficulty : Moderate

Average Time : 56 Seconds

Options :

1. was fractured
2. who's leg
3. has recovered
4. My friend

Solution :

The correct answer is **option 2** i.e. **who's leg**.

- The second part of the sentence is erroneous in nature.
- Instead of 'who's leg,' we should use 'whose leg.'
- Whose is used to exactly tell which person or thing is being talked about.
- The narrator tells about the leg of his friend.

The correct sentence is:

My friend **whose** leg was fractured has recovered.

Question 30 :

Select the most appropriate option to substitute the underlined segment in the given sentence. If there is no need to substitute it, select 'No substitution required'. It is quite difficult to make on what this doctor writes.

Difficulty : Moderate

Average Time : 61 Seconds

Options :

1. make out
2. made on
3. make in
4. No substitution required

Solution :

The correct answer is **option 1** i.e. **make out**

The meaning of the given words is:

- **Make out:** manage with some difficulty to see or hear someone or something.
- **Made on:** to turn on, light, or ignite

**Make in:** To earn some amount of money from a particular career, pursuit, or undertaking.

The correct sentence is:

It is quite difficult to make out what this doctor writes.

**Question 31 :**

Shashank walks a certain distance, say  $X$  m, towards the west, then turns left and walks 35 m, and then turns right and walks 18 m. From there, he turns left and walks 9 m, and then turns left again and walks 60 m. From there, he turns left and walks 9 m, and then turns left again and walks 12 m. He finally turns right and walks 35 m to reach a point that is exactly 10 m to the east of the starting point. What is the value of  $X$ ?

Difficulty : Moderate

Average Time : 76 Seconds

Options :

- 30
- 36
- 22
- 20

**Solution :**

The correct answer is **option 4** i.e. **20**.

Using the above information we can draw the following diagram:

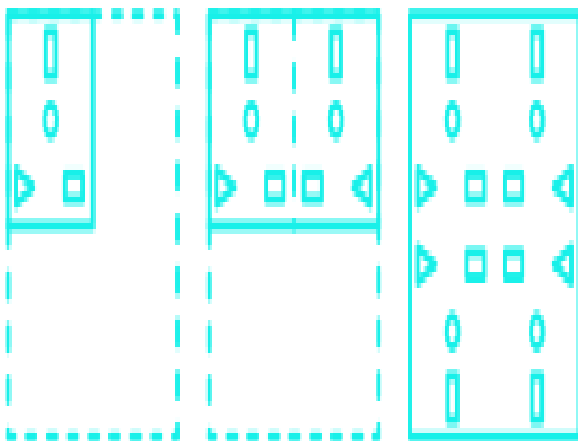

From the figure,



$$AB = EF - CD - GH - IA$$

$$AB = 60 - 18 - 12 - 10$$

$$AB = x = 20\text{mts}$$

Hence, **option 4** is the correct answer.

**Question 32 :**

Select the most appropriate option to substitute the underlined segment in the given sentence. If there is no need to substitute it, select option 'No substitution required'. Often it makes one wonder at the sights you see.

Difficulty : Moderate

Average Time : 56 Seconds

**Options :**

1. you saw
2. one sees
3. one see
4. No substitution required

**Solution :**

The correct answer is **option 2** i.e. **one sees**.

- The underlined part of the sentence is erroneous.
- Instead of 'you see', one sees should be used.
- One means any person but not a particular person.
- Whenever we use one in a sentence, we mostly use it as pronouns.
- Moreover, one is a singular subject, thus, a singular verb should be used.

**Thus, the correct sentence is:**

*Often it makes one wonder at the sights one sees.*

**Question 33 :**

Sentences of a paragraph are given below in jumbled order. Arrange the sentences in the correct order to form a meaningful and coherent paragraph. A. Thus, shared laughter is one of the most effective tools in maintaining healthy relationships. B. Emotional sharing builds strong and lasting bonds. C. It also helps in healing resentments and hurt. D. But sharing laughter brings joy and freshness to relationships.

Difficulty : Moderate

Average Time : 70 Seconds

**Options :**



BDCA

2. DCAB

3. BCAD

4. DCBA

**Solution :**

The correct answer is **option 1** i.e. **BDCA**

- The first statement of the given paragraph should always be independent, a fact, or a starting incident.
- **Sentence B** contains the main idea of the given paragraph which is emotional sharing.
- **Sentence D** tells what happens when you share laughter. So, sentence D will follow sentence B.
- **Sentence C** further elaborates that laughter helps in healing resentments.
- **Sentence A** concludes laughter as the most effective tool in maintaining good relationships.

**The correct paragraph is:**

*Emotional sharing builds strong and lasting bonds. But sharing laughter brings joy and freshness to relationships. It also helps in healing resentments and hurt. Thus, shared laughter is one of the most effective tools for maintaining healthy relationships.*

**Comprehension :**

Directions: In the following passage, some words have been deleted. Read the passage carefully and select the most appropriate option to fill in each blank. For an average Indian, driving in any of the major Indian cities is equivalent to (1) \_\_\_\_\_ a daily war. The everyday struggle of (2) \_\_\_\_\_ traffic, pollution, and rash drivers are (3) \_\_\_\_\_ biggest cause of chronic stress and other (4) \_\_\_\_\_ problems. On average a person spends (5) \_\_\_\_\_ between thirty minutes to two hours of their day driving.

**Question 34 :**

Select the most appropriate option to fill in blank no.1.

Difficulty : Moderate

Average Time : 89 Seconds

**Options :**

1. waging
2. making
3. raising
4. rushing

**Solution :**



The correct answer is **option 1** i.e. **waging**.

The meaning of the given words is:

- **Waging:** carry on a war or campaign.
- **Making:** the process of making or producing something.
- **Raising:** lift or move to a higher position or level.
- **Rushing:** moving with urgent haste.

The correct sentence is:

For an average Indian, driving in any of the major Indian cities is equivalent to **waging** a daily war.

**Comprehension :**

Directions: In the following passage, some words have been deleted. Read the passage carefully and select the most appropriate option to fill in each blank. For an average Indian, driving in any of the major Indian cities is equivalent to (1) \_\_\_\_\_ a daily war. The everyday struggle of (2) \_\_\_\_\_ traffic, pollution, and rash drivers are (3) \_\_\_\_\_ biggest cause of chronic stress and other (4) \_\_\_\_\_ problems. On average a person spends (5) \_\_\_\_\_ between thirty minutes to two hours of their day driving.

**Question 35 :**

Select the most appropriate option to fill in blank no.2.

Difficulty : Moderate

Average Time : 77 Seconds

**Options :**

1. lodging
2. dodging
3. boarding
4. stopping

**Solution :**

The correct answer is **option 2** i.e. **dodging**.

The meaning of the given words is:

- **Lodging:** temporary accommodation.
- **Dodging:** avoid someone or something by a sudden quick movement.
- **Boarding:** long, flat, thin pieces of wood used to build or cover something.
- **Stopping:** a filling for a tooth.



The correct sentence is:

The everyday struggle of **dodging** traffic, pollution.....

### Comprehension :

Directions: In the following passage, some words have been deleted. Read the passage carefully and select the most appropriate option to fill in each blank. For an average Indian, driving in any of the major Indian cities is equivalent to (1) \_\_\_\_\_ a daily war. The everyday struggle of (2) \_\_\_\_\_ traffic, pollution, and rash drivers is (3) \_\_\_\_\_ the biggest cause of chronic stress and other (4) \_\_\_\_\_ problems. On average a person spends (5) \_\_\_\_\_ between thirty minutes to two hours of their day driving.

### Question 36 :

Select the most appropriate option to fill in blank no.4.

Difficulty : Moderate

Average Time : 77 Seconds

### Options :

1. spiritual
2. societal
3. psychological
4. ecological

### Solution :

The correct answer is **option 3** i.e. **psychological**

### The meaning of the given words is:

- **Spiritual:** relating to religion or religious belief.
- **Societal:** relating to society or social relations.
- **Psychological:** related to the mental and emotional state of a person.
- **Ecological:** relating to or concerned with the relation of living organisms to one another and to their physical surroundings.

The correct sentence is:

.....the biggest cause of chronic stress and other **psychological** problems.





## Comprehension :

Directions: In the following passage, some words have been deleted. Read the passage carefully and select the most appropriate option to fill in each blank. For an average Indian, driving in any of the major Indian cities is equivalent to (1) \_\_\_\_\_ a daily war. The everyday struggle of (2) \_\_\_\_\_ traffic, pollution, and rash drivers is (3) \_\_\_\_\_ the biggest cause of chronic stress and other (4) \_\_\_\_\_ problems. On average, a person spends (5) \_\_\_\_\_ between thirty minutes to two hours of their day driving.

### Question 37 :

Select the most appropriate option to fill in blank no.5.

Difficulty : Moderate

Average Time : 80 Seconds

### Options :

1. everywhere
2. nowhere
3. elsewhere
4. anywhere

### Solution :

The correct answer is **option 4** i.e. **anywhere**.

- The given filler needs to be filled with an adverb that closely means approximately.

### The meaning of the given words is:

- **Everywhere:** in or to all places.
- **Nowhere:** not in or to any place; not anywhere.
- **Elsewhere:** anywhere or somewhere else
- **Anywhere:** in or to any place.

### Thus, the most appropriate sentence is:

*On average, a person spends **anywhere** between thirty minutes to two hours of their day driving.*

### Question 38 :

Select the most appropriate synonym of the given word. Lull

Difficulty : Moderate

Average Time : 61 Seconds

Options :

1. Activity
2. Disturbance
3. Noise
4. Calm

Solution :

The correct answer is **option 4** i.e. **Calm**

The meaning of the given words is:

- **Lull**: calm or send to sleep, typically with soothing sounds or movements.
- **Activity**: the condition in which things are happening or being done.
- **Disturbance**: the interruption of a settled and peaceful condition.
- **Calm**: pleasantly free from wind.

The most appropriate synonym for **Lull** is **calm**.

Question 39 :

Select the most appropriate antonym of the given word. Multiple

Difficulty : Moderate

Average Time : 53 Seconds

Options :

1. triple
2. double
3. many
4. single

Solution :

The correct answer is **option 4** i.e. **Single**.

The meaning of the given words is:



**Multiple:** having or involving several parts, elements, or members.

- **Triple:** three times as much or as many.
- **Double:** two times as much or as many.
- **Many:** a large number of.
- **Single:** only one; not one of several.

Thus, the most appropriate antonym of '**Multiple**' is '**Single**.'

### Question 40 :

Select the most appropriate meaning of the given idiom. Have a change of heart

Difficulty : Moderate

Average Time : 56 Seconds

### Options :

1. Undergo a surgery
2. Change one's opinion
3. Express happiness about something
4. Fall in love with someone

### Solution :

The correct answer is **option 2** i.e. **Change one's opinion**.

- The meaning of the given idiom, "**Have a change of heart**" is a move to a different opinion or attitude.

Thus, the most appropriate choice would be **Change one's opinion**.

### Question 41 :

Select the most appropriate option to fill in the blank. \_\_\_\_\_ did she open her lunch box than everyone gathered around her.

Difficulty : Moderate

Average Time : 50 Seconds

### Options :

1. No sooner
2. Hardly
3. Just as
4. As soon as

**Solution :**

The correct answer is **option 1** i.e. **No sooner**

- '**No sooner**' and '**than**' are correlative conjunction.
- This implies that 'no sooner' is always followed by 'than'.

Thus, the most appropriate filler is **No sooner**.

**The correct sentence is:**

***No sooner** did she open her lunch box than everyone gathered around her.*

**Question 42 :**

If the signs '-' and 'x' are interchanged, then which of the following equations can be correctly balanced?

**Difficulty : Moderate****Average Time : 53 Seconds****Options :**

1.  $42 \div 6 - 18 + 30 \times 7 = 146$
2.  $64 \div 8 - 22 \times 3 + 30 = 103$
3.  $119 \div 17 - 6 + 24 \times 34 = 32$
4.  $36 + 14 \times 18 \div 3 - 12 = 72$

**Solution :**

The correct answer is **option 3** i.e.  $119 \div 17 - 6 + 24 \times 34 = 32$ .

**Given conditions:** Signs '-' and 'x' are interchanged

**Option 1:**  $42 \div 6 - 18 + 30 \times 7 = 146$

After interchanging the expression becomes:

$$= 42 \div 6 \times 18 + 30 - 7 = 146$$

$$= 149 \text{ is not equal to } 146.$$

**Option 2:**  $64 \div 8 - 22 \times 3 + 30 = 103$

After interchanging the expression becomes:

$$= 64 \div 8 \times 22 - 3 + 30 = 103$$

$$= 203 \text{ is not equal to } 103.$$



**Option 3:**  $119 \div 17 - 6 + 24 \times 34 = 32$

After interchanging the expression becomes:

$$= 119 \div 17 \times 6 + 24 - 34 = 32$$

= 32 is equal to 32.

As we have found our answer, there is no need for checking other options.

Hence, **option 3** is the correct answer.

#### Question 43 :

Select the number from among the given options that can replace the question mark (?) in the following series. 55, 63, ?, 343, 855, 1855

Difficulty : Moderate

Average Time : 69 Seconds

#### Options :

1. 117
2. 127
3. 223
4. 135

#### Solution :

The correct answer is **option 2** i.e. **127**.

Given series: 55, 63, ?, 343, 855, 1855

The series follows this pattern:

$$55 + 2^3 = 55 + 8 = 63$$

$$63 + 4^3 = 63 + 64 = 127$$

$$127 + 6^3 = 127 + 216 = 343$$

$$343 + 8^3 = 343 + 512 = 855$$

$$855 + 10^3 = 855 + 1000 = 1855$$

So, the missing term in the series is **127**.

#### Question 44 :

Six students, Abhay, Bhanu, Charu, David, Ekta, and Farheen, are the top six rank holders in the school. The rank of



Bhanu is between the ranks of Charu and David. Bhanu is in the fourth rank. There are two students between the ranks of Ekta and David. Ekta is at the lowest rank among all the given students. The rank of Abhay is immediately below the rank of Farheen. Who is on the fifth rank?

**Difficulty : Moderate**

**Average Time : 59 Seconds**

**Options :**

1. Ekta
2. Abhay
3. David
4. Charu

**Solution :**

The correct answer is **option 4** i.e. **Charu**.

According to the question, the arrangement is as follows:

1. Farheen
2. Abhay
3. David
4. Bhanu
5. Charu
6. Ekta

From the above arrangement, Charu is in the fifth rank.

Hence, **option 4** is the correct answer.

**Question 45 :**

Read the given statements and conclusions carefully. Assuming that the information given in the statements is true, even if it appears to be at variance with commonly known facts, decide which of the given conclusions logically follow(s) from the statements. Statements: Some locks are keys. No key is a chain. All springs are chains. Conclusions: I. Some keys are springs. II. No key is a spring. III. No lock is a spring.

**Difficulty : Moderate**

**Average Time : 62 Seconds**

**Options :**

Only conclusions I and II follow.

2. Only conclusion II follows.

3. None of the conclusions follow.

4. Either conclusion I or II follows.

**Solution :**

The correct answer is **option 2** i.e. **Only conclusion II follows.**

The least possible Venn Diagram for the given statements is drawn below:

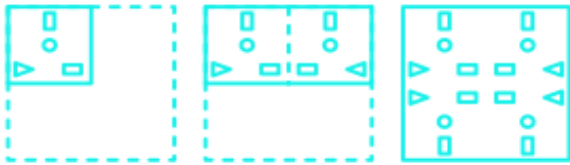
**Conclusions:**

I. Some keys are springs **False** (It is possible, but no definite conclusion can be drawn).

II. No key is a spring **True** (As some locks are keys, no key is a chain, and all springs are chains then no key is a spring is true).

III. No lock is a spring **False** (It is possible, but no definite conclusion can be drawn).

Hence, **Only conclusion II follows.**

**Question 46 :**

Select the option that expresses the given sentence in active voice. He is given proper guidance by his boss.

Difficulty : Moderate

Average Time : 75 Seconds

**Options :**

1. His boss has been giving him proper guidance.
2. He gives proper guidance to his boss.
3. His boss gives him proper guidance.
4. His boss is giving him proper guidance.

**Solution :**

The correct answer is **option 3** i.e. **His boss gives him proper guidance.**



**The structure of the Passive voice is:** Subject (Object)+ is/am/are + V3 +Object (subject)

- **The structure of Active voice is:** Subject + V1 + Object
  - The verb is will be removed.
  - And given will be changed into gives.
  - The subject and object will interchange their position

**Thus, the correct sentence is:**

*His boss gives him proper guidance.*

**Question 47 :**

Vaidehi got 92% marks in an examination and Kavyanjali got 78% marks in the same examination. If the difference between the marks obtained by Vaidehi and Kavyanjali is 105, find the marks obtained by Vaidehi in the examination.

**Difficulty : Moderate**

**Average Time : 67 Seconds**

**Options :**

1. 598
2. 736
3. 690
4. 644

**Solution :**

The correct answer is **option 3** i.e. **690**.

Let the total marks be x.

According to the question;

$$92\% \text{ of } x - 78\% \text{ of } x = 105$$

$$(92 - 78)/100 \text{ of } x = 105$$

$$(92 - 78)/100 \text{ of } x = 105$$

$$14 \times x = 10500$$

$$x = 750$$

Marks obtained by Vaidehi in the examination =  $92/100 \times 750 = 690$

**Question 48 :**

Select the dice that can be formed by folding the given sheet along the lines.



Difficulty : Moderate

Average Time : 46 Seconds

Options :

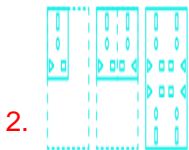
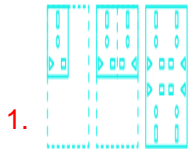

Solution :

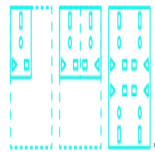

The correct answer is **option 3**.

After folding the sheet along the lines;

6 is opposite to 4.

1 is opposite to 2.

3 is opposite to 5.

In dice 1, opposite pairs 1 and 2 are adjacent to each other, so dice 1 cannot be formed.

In dice 2, opposite pairs 3 and 5 are adjacent to each other, so dice 2 cannot be formed.

In dice 3, no opposite pairs are adjacent to each other, so dice 3 can be formed.

Question 49 :



Four letter clusters have been given, out of which three are alike in some manner and one is different. Select the one that is different.

**Difficulty : Moderate**

**Average Time : 80 Seconds**

**Options :**

1. WTP
2. VSQ
3. PMK
4. MJH

**Solution :**

The correct answer is **option 1** i.e. **WTP**.

The logic used here is:

1st letter - 3 = 2nd letter

2nd letter - 2 = 3rd letter

**Option 1: WTP**

W - 3 = T

T - 3 = Q

This does not follow the logic.

Hence, **option 1** is the odd one out.

**Question 50 :**

Which two signs need to be interchanged to make the following equation correct?  $95 \div 19 \times 3 - 7 + 29 = 13$

**Difficulty : Moderate**

**Average Time : 48 Seconds**

**Options :**

1. + and ×
2. - and ×
3. - and +
4. ÷ and -

### Solution :

The correct answer is **option 2** i.e. – and ×.

**Given equation:**  $95 \div 19 \times 3 - 7 + 29 = 13$

**Given conditions:** Signs '+' and '÷' are interchanged

#### Option 1: + and ×

After interchanging the expression becomes:

$$= 95 \div 19 + 3 - 7 \times 29 = 13$$

= -195 is not equal to 13.

#### Option 2: – and ×

After interchanging the expression becomes:

$$= 95 \div 19 - 3 \times 7 + 29 = 13$$

= 13 is equal to 13.

As we have found our answer, there is no need for checking other options.

Hence, **option 2** is the correct answer.

### Question 51 :

Select the Venn diagram that best represents the relationship among the following classes. Electronic gadgets, Mobile phones, Table, Laptops

Difficulty : Moderate

Average Time : 64 Seconds

#### Options :

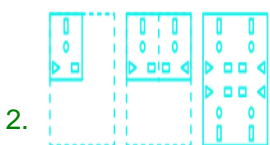
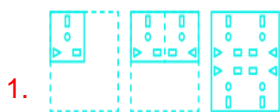

3.

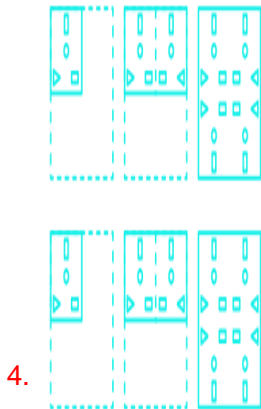

**Solution :**

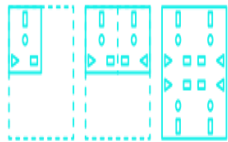

The correct answer is **option 2**.

The possible Venn diagram is:

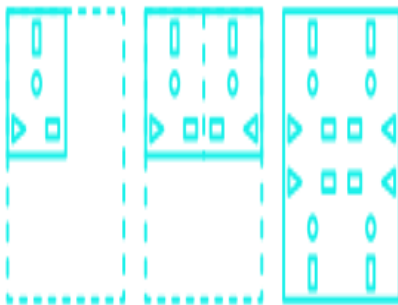

All mobile phones and laptops are electronic gadgets. The table is a different class.

Hence, the diagram given above shows the best relationship between them.

**Question 52 :**

In a certain code, 34225 means 'Red fort is in Delhi' and 5248 means 'Delhi is very polluted'. Which of the following is the code for 'Pollution level is changing'?

**Difficulty :** Moderate

**Average Time :** 79 Seconds

**Options :**

- 7859

9528

3. 5548

4. 1528

**Solution :**

The correct answer is **option 2** i.e. **9528**.

The logic used here is:

Code is the number of letters in the word.

34225 means 'Red fort is in Delhi'

Code for the word red = 3

Code for the word fort = 4

Code for the word is = 2

Code for the word in = 2

Code for the word Delhi = 5

Similarly;

Code for the word phrase 'Pollution level is changing' = 9528

Hence, **option 2** is the correct answer.

**Question 53 :**

Select the number from among the given options that can replace the question mark (?) in the following series. 9, 29, 67, 129, ?, 349

Difficulty : Moderate

Average Time : 55 Seconds

**Options :**

1. 221

2. 185

3. 179

4. 242

**Solution :**

The correct answer is **option 1** i.e. **221**.

Given series: 9, 29, 67, 129, ?, 349

The series follows this pattern:

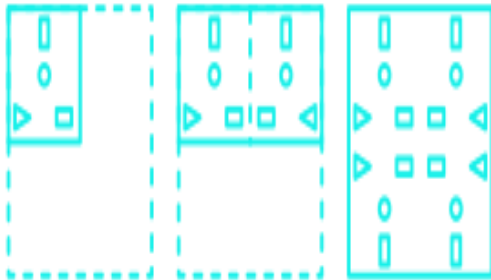

So, the missing term in the series is **221**.

**Question 54 :**

Select the correct option that indicates the arrangement of the given words in the order in which they appear in an English dictionary. 1. Tranquil 2. Transit 3. Transfer 4. Transient 5. Training

**Difficulty : Moderate**

**Average Time : 46 Seconds**

**Options :**

- 1. 5, 1, 3, 4, 2
- 2. 5, 1, 4, 3, 2
- 3. 5, 1, 3, 2, 4
- 4. 2, 5, 3, 4, 1

**Solution :**

The correct answer is **option 1** i.e. **5, 1, 3, 4, 2**.

In this question, you need to arrange the words as they would appear in the English dictionary.

- 1. Training
- 2. Tranquil
- 3. Transfer
- 4. Transient
- 5. Transit

**Question 55 :**

Study the given matrix carefully and select the number from among the given options that can replace the question mark (?) in it. 12 7 70 15 6 78 11 9 ?

**Difficulty : Moderate****Average Time : 41 Seconds****Options :**

1. 76
2. 85
3. 81
4. 75

**Solution :**

The correct answer is **option 3** i.e. **81**.

The logic used here is:

**Row 1:**  $(12 - 2) \times 7 = 10 \times 7 = 70$

**Row 2:**  $(15 - 2) \times 6 = 13 \times 6 = 78$

**Row 3:**  $(11 - 2) \times 9 = 9 \times 9 = 81$

**Question 56 :**

In a certain code language, 'PENCIL' is written as 'MKFRJV' and 'ERASER' is written as 'SGVEWK'. How will 'MASTER' be written in that language?

**Difficulty : Moderate****Average Time : 43 Seconds****Options :**

1. SGWWFS
2. RFWVES
3. REWWGT
4. SFWYFT

**Solution :**

The correct answer is **option 1** i.e. **SGWWFS**.

The logic used here is:



'PENCIL' is written as 'MKFRJV'

$$P + 6 = V$$

$$E + 5 = K$$

$$N + 4 = R$$

$$C + 3 = F$$

$$I + 2 = K$$

$$L + 1 = M$$

$$\text{PENCIL} = \text{MKFRV}$$

Similarly,

Code for the word MASTER:

$$M + 6 = S$$

$$A + 5 = F$$

$$S + 4 = W$$

$$T + 3 = W$$

$$E + 2 = G$$

$$R + 1 = S$$

$$\text{MASTER} = \text{SGWWFS}$$

Hence, **option 1** is the correct answer.

**Question 57 :**

Select the letter clusters from among the given options that can sequentially replace both the question marks (?) in the following series. ZCKR, bfow, DISB, flwg, HOAL, ?, ?

**Difficulty :** Moderate

**Average Time :** 58 Seconds

**Options :**

1. jrfq, LUIW

2. jres, LUIX

3. jreq, LUIV



**JREQ, luiw**

**Solution :**

The correct answer is **option 3** i.e. **jreq, LUIV**.

Given series: ZCKR, bfow, DISB, flwg, HOAL, ?,?

The series follows this pattern:

ZCKR, bfow

$$Z + 2 = b$$

$$C + 3 = f$$

$$K + 4 = o$$

$$R + 5 = w$$

Similarly;

HOAL, ?,?

$$H + 2 = j$$

$$O + 3 = r$$

$$A + 4 = e$$

$$L + 5 = q$$

$$j + 2 = L$$

$$r + 3 = U$$

$$e + 4 = I$$

$$q + 5 = V$$

So, the next term in the series is **jreq, LUIV**.

**Question 58 :**

Ranjana said to a woman, "My father is the paternal grandfather of your son Piyush". How is Piyush related to Ranjana?

**Difficulty : Moderate**

**Average Time : 59 Seconds**

**Options :**

1. **Cousin**

Grandson

3. Brother

4. Nephew

**Solution :**

The correct answer is **option 4** i.e. **Nephew**.

In the diagram shown;

Square shows males, the circle shows females, vertical lines show generations, a single horizontal line shows brothers or sisters, and double lines show a couple.

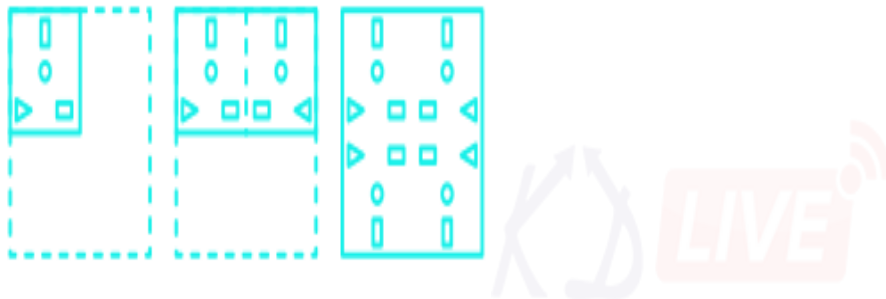

From the above figure, Piyush is the nephew of Ranjana.

Hence, **option 4** is the correct answer.

**Question 59 :**

In a certain code language, 'STREAM' is coded as 161418445228. How will 'PERIOD' be coded in that language?

Difficulty : Moderate

Average Time : 54 Seconds

**Options :**

1. 244418342446

2. 224418382448

3. 224418362446

4. 224420363046

**Solution :**

The correct answer is **option 3** i.e. **224418362446**.

The logic used here is:



'STREAM' is coded as 161418445228

Opposite of S = H =  $8 \times 2 = 16$

Opposite of T = G =  $7 \times 2 = 14$

Opposite of R = I =  $9 \times 2 = 18$

Opposite of E = V =  $22 \times 2 = 44$

Opposite of A = Z =  $26 \times 2 = 52$

Opposite of M = N =  $14 \times 2 = 28$

Similarly,

Code for the word PERIOD:

Opposite of P = K =  $1 \times 2 = 22$

Opposite of E = V =  $22 \times 2 = 44$

Opposite of R = I =  $9 \times 2 = 18$

Opposite of I = R =  $18 \times 2 = 36$

Opposite of O = L =  $12 \times 2 = 24$

Opposite of D = W =  $23 \times 2 = 46$

Hence, **option 3** is the correct answer.

**Question 60 :**

Select the number-pair in which the two numbers share the same relationship as that shared by the given pair of numbers.

14: 421

Difficulty : Moderate

Average Time : 65 Seconds

**Options :**

1. 11: 265

2. 18: 611

3. 16: 421

4. 13: 310

**Solution :**

The correct answer is **option 1** i.e. **11: 265**.

The logic used here is:

14: 421

$$14^2 + (14 + 1)^2 = 196 + 225 = 421$$

Similarly,

11: 265

$$11^2 + (11 + 1)^2 = 121 + 144 = 265$$

Hence, **option 1** is the correct answer.

### Question 61 :

Select the correct mirror image of the given figure when the mirror is placed at 'AB' as shown.

Difficulty : Moderate

Average Time : 42 Seconds

Options :

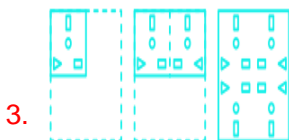
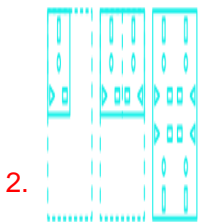
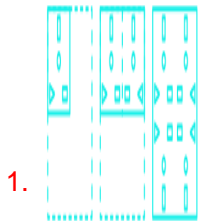

4.

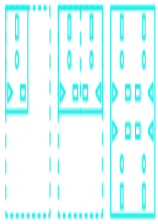

**Solution :**

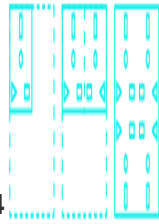

The correct answer is **option 4**.

The mirror image of the question figure is shown below:

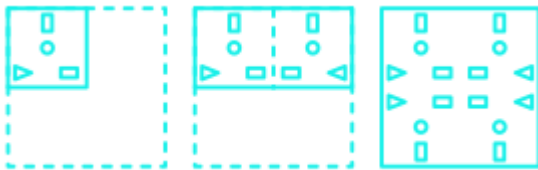

Since the mirror is placed right to the question figure, the right-hand side of the original image will be now the left-hand side of the mirror image.

Hence, **option 4** is the correct answer.

**Question 62 :**

Select the figure from among the given options that can replace the question mark (?) in the following series.

**Difficulty : Moderate**

**Average Time : 78 Seconds**

**Options :**

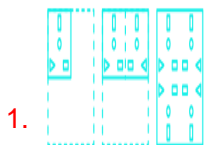

2.

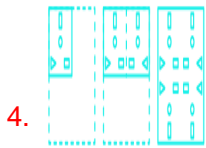
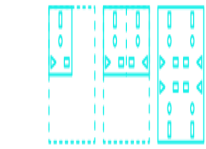

**Solution :**



The correct answer is **option 2** i.e.

Here, the shapes get changed following a certain pattern except for the circle which remains in its own place (innermost shape).

All the shapes get shifted from the outermost to the second innermost shape.

Also, the shaded portion will be different in each image.

A circle is inside the square (4 sides), the square is inside the pentagon (5 sides), and the pentagon is inside the hexagon (6 sides).

So, the pattern is circle (which remains in the same place) 4 sides 5 sides 6 sides.

The outermost part is shaded.

circle 6 sides 4 sides 5 sides

The second outermost part is shaded.

circle 5 sides 6 sides 4 sides

The third outermost part is shaded.

circle 4 sides 5 sides 6 sides.

The second innermost (fourth outermost) part will be shaded.

**Question 63 :**

The Contingency Fund of India is to be augmented from ₹1,500 crores to \_\_\_\_\_crores through the Finance Bill as per the Union Budget 2021-22.

**Difficulty : Moderate****Average Time : 104 Seconds****Options :**

1. ₹1,15,000
2. ₹1,30,000
3. ₹1,25,000
4. ₹1,10,000

**Solution :**

The correct answer is **option 2** i.e. **₹1,30,000**

- The Contingency Fund of India is to be augmented from ₹1,500 crores to **₹1,30,000** crores through the Finance Bill as per the Union Budget 2021-22.
- The fund can be increased through a Finance Bill when the Parliament is in the session. Or through Ordinance if the House is not in session and situation warrants. Withdrawal from the fund takes place with the approval of the Secretary of Department of Economic Affairs, in terms of the Contingency Fund of India Act, 1950.

**Question 64 :**

The Hirakud Dam is built near the city of \_\_\_\_\_ in Odisha.

**Difficulty : Moderate****Average Time : 52 Seconds****Options :**

1. Balasore
2. Cuttack
3. Rourkela
4. Sambalpur

**Solution :**

The correct answer is **option 4** i.e. **Sambalpur**

- The Hirakud Dam is built near the city of **Sambalpur** in Odisha.
- Hirakud Dam is built across the **Mahanadi River**, about 15 kilometers (9 mi) from **Sambalpur** in the state of Odisha. It is the longest earthen dam in the world. Behind the dam extends a lake, Hirakud Reservoir, 55 km (34 mi)

long. It is one of the first major multipurpose river valley projects started after India's independence. Hirakud Reservoir was declared a **Ramsar site** on **12 October 2021**.

**Question 65 :**

Which of the following festivals is celebrated in Uttarakhand?

Difficulty : Moderate

Average Time : 57 Seconds

**Options :**

1. Phool Dei
2. Nuakhai
3. Vishu
4. Dol Jatra

**Solution :**

The correct answer is **option 1** i.e. **Phool Dei**.

- The festival of **Phool Dei** is celebrated in the Garhwal and Kumaun regions of Uttarakhand every year in the flowering season (March-April) for about a month.
- **Phool Dei** is a reverence paid to the gods for the good crop year. It is on this occasion little girls decorate the threshold of the houses with freshly picked flowers.

**Question 66 :**

Which of the following Hero Indian Super League teams appointed Sergio Lobera as its head coach in October 2020?

Difficulty : Moderate

Average Time : 52 Seconds

**Options :**

1. Mumbai City FC
2. Bengaluru FC
3. North East United FC
4. ATK Mohun Bagan

**Solution :**

The correct answer is **option 1** i.e. **Mumbai City FC**

- **Mumbai City FC** appointed Sergio Lobera as its head coach in October 2020. The Spaniard has a wealth of coaching experience in leagues around the world in a career spanning almost 25 years. Lobera has managed clubs



in Spain, Morocco and in India and was also the assistant manager of FC Barcelona in 2012. Lobera was most recently Head Coach at FC Goa, winning the Super Cup in 2019.

**Question 67 :**

Acceleration is equal to the rate of change of \_\_\_\_\_.

Difficulty : Moderate

Average Time : 51 Seconds

**Options :**

1. displacement
2. position
3. momentum
4. velocity

**Solution :**

The correct answer is **option 4** i.e. **velocity**

- Acceleration is equal to the rate of change of **velocity**.
- It is denoted by  $a$ .

$(a = \frac{dv}{dt})$  (velocity,  $t = \text{time}$ )

$(v = \frac{\text{distance}}{\text{time}})$ , here unit of distance is in meters and time in seconds and thus the unit of velocity is m/s.

Therefore, the unit of acceleration is  $\text{m/s}^2$

Thus, acceleration is defined as the rate of change in **velocity**.

**Question 68 :**

Acidic drain cleaners made of \_\_\_\_\_ or \_\_\_\_\_ acid are powerful enough to clear heavy-duty hair, food, grease, soap scum or paper-based clogs in 15 minutes or less.

Difficulty : Moderate

Average Time : 59 Seconds

**Options :**

1. sulphuric, hydrochloric
2. formic, citric
3. nitric, carbonic
4. malic, lactic

**Solution :**

The correct answer is **option 1** i.e. **sulphuric, hydrochloric**

- Acidic drain cleaners made of **sulfuric** or **hydrochloric acid** are powerful enough to clear heavy-duty clogs like hair, food, grease, soap scum, or paper-based clogs in 15 minutes or less.
- Acidic drain cleaners are generally safe for newer plastic or metal pipes (e.g., copper) in the sink, tub, shower, and toilet drains.
- They work by a process of acid hydrolysis to dissolve the fats and solids that create a drain blockage.
- Acid hydrolysis is the process of breaking down larger molecules into smaller molecules by adding acid and water to a substance.

**Question 69 :**

What is the maximum permissible limit of turbidity in potable water as per the Bureau of Indian Standards (BIS)(IS -10500 : 2012)?

Difficulty : Moderate

Average Time : 63 Seconds

**Options :**

1. 5 NTU
2. 1 NTU
3. 3 NTU
4. 7 NTU

**Solution :**

The correct answer is **option 1** i.e. **5 NTU**

- The maximum permissible limit of turbidity in potable water as per the Bureau of Indian Standards (BIS)(IS -10500 : 2012) is **5 NTU**.
- In water, Turbidity is produced by suspended particulate matter like plankton, inorganic and organic matter, silt, clay, as well as another microscopic organisms or colloidal matter, which obstructs light transmission in water.
- Turbidity level should be maintained between 1 and 5 NTU to keep desirable drinking water quality.

**Question 70 :**

Who among the following was an ancient Indian mathematician-astronomer?

Difficulty : Moderate

Average Time : 50 Seconds

**Options :**

1. Banabhatta



Varahamihira

3. Nagarjuna

4. Amalananda

### Solution :

The correct answer is **option 2** i.e. **Varahamihira**

- **Varahamihira** was an ancient Indian mathematician-astronomer.
- He was born at Kapitba, in the Avanti region, which roughly corresponds to present-day Malwa (a region of Madhya Pradesh, India). In one of his own writings, he claims to have attended Kapitthaka for his education.
- According to Indian traditions, he was one of the “Nine Jewels” (Navaratnas) at the court of Malwa king Yashodharman Vikramaditya.
- The most famous work by **Varahamihira** is the **Pancasiddhantika** (The Five Astronomical Canons) dated **575 AD**.

### Question 71 :

Which of the following statements about ‘Swachh Survekshan - Urban’ is INCORRECT?

Difficulty : Moderate

Average Time : 58 Seconds

### Options :

1. It was launched as part of the Swachh Bharat Abhiyan.
2. The first survey was undertaken in 2016.
3. It is an annual survey of cleanliness, hygiene and sanitation in cities and towns across India.
4. It is conducted by the Ministry of Health and Family Welfare.

### Solution :

The correct answer is **option 4** i.e. **It is conducted by the Ministry of Health and Family Welfare**.

- The statement **it is conducted by thr Ministry of Health and Family Welfare** is incorrect.
- Swachh Survekshan is an annual survey of cleanliness, hygiene and sanitation in cities and towns across India.
- It was launched as part of the Swachh Bharat Abhiyan, which aimed to make India clean and free of open defecation by 2nd October 2019.
- The first survey was undertaken in 2016.
- It was conducted by the Ministry of Housing and Urban Affairs (MoHUA) with Quality Council of India (QCI) as its implementation partner.
- The cities have been ranked based on three broad parameters: service level progress, citizen’s voice and



certification.

**Question 72 :**

Decrease in which of the following factors leads to an increase in the rate of evaporation?

Difficulty : Moderate

Average Time : 76 Seconds

**Options :**

1. Ambient temperature
2. Area of the free surface of the liquid concerned
3. Wind speed above the surface of the liquid
4. Humidity

**Solution :**

The correct answer is **option 4** i.e. **Humidity**

- Decrease in **humidity** leads to an increase in the rate of evaporation.
- Evaporation can be defined as the process through which a liquid is converted into a gas/vapour without being heated to its boiling point. The key factors that affect the rate of evaporation of a liquid are:
  1. Temperature- The greater the temperature of the liquid and its surroundings, the faster the rate of evaporation.
  2. Surface area occupied by the liquid- Since evaporation is a surface phenomenon, the greater the surface area occupied by the liquid, the quicker it undergoes evaporation.
  3. Humidity of the surroundings- The greater the humidity of the atmosphere surrounding the water, the slower the rate of evaporation.
  4. Air circulation or wind speed- The presence of a breeze or another source of air circulation directly contributes towards the rate of evaporation.

**Question 73 :**

The following sentence has been split into four segments. Identify the segment that contains a grammatical error. Will you / care for / a cup of / hot coffee?

Difficulty : Moderate

Average Time : 80 Seconds

**Options :**

1. Will you
2. hot coffee
3. care for

a cup of

**Solution :**

The correct answer is **option 1** i.e. **Will you**

- The first part of the given sentence is erroneous in nature.
- Instead of 'would you,' 'will you' should be used.

**Thus, the correct sentence is:**

*Would you care for a cup of hot coffee?*

**Question 74 :**

The sequence of folding a piece of paper and the manner in which the folded paper has been cut is shown in the following figures. How would this paper look when unfolded?

**Difficulty : Moderate**

**Average Time : 51 Seconds**

**Options :**

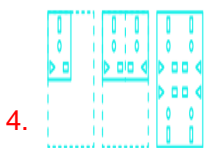
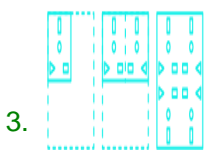
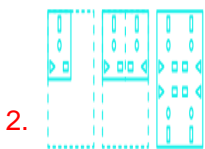
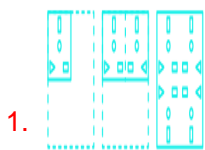

**Solution :**

The correct answer is **option 3**

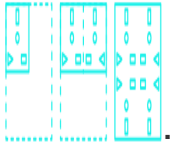

After unfolding, the paper will appear as follows:



### Question 75 :

Select the option that is related to the third letter cluster in the same way as the second letter cluster is related to the first letter cluster. DFC: WHX:: KFQ:?

Difficulty : Moderate

Average Time : 71 Seconds

### Options :

1. PHJ
2. QHJ
3. QHK
4. RGK

### Solution :

The correct answer is **option 1** i.e. **PHJ**.

The logic used here is:

DFC: WHX

Opposite to D = W

F + 2 = H

Opposite to C = X

Similarly,

KFQ:?

Opposite to K = P



$$F + 2 = H$$

Opposite to Q = J

Hence, **option 1** is the correct answer.

**Question 76 :**

Select the combination of letters that when sequentially placed in the blanks of the given series will complete the series. L

G \_ Q \_ G P \_ L \_ P Q \_ G \_ Q

**Difficulty : Moderate**

**Average Time : 51 Seconds**

**Options :**

1. P, L, P, G, L, Q
2. P, L, Q, G, L, P
3. P, Q, L, G, P, L
4. P, P, L, G, Q, L

**Solution :**

The correct answer is **option 2** i.e. **P, L, Q, G, L, P**.

The sequence is – P, L, Q, G, L, P

Given sequence: L G \_ Q \_ G P \_ L \_ P Q \_ G \_ Q

**Option 1: P, L, P, G, L, Q**

L G P Q L G P P L G P Q L G Q Q

Option 1 does not form a particular pattern.

**Option 2: P, L, Q, G, L, P**

L G P Q / L G P Q / L G P Q / L G P Q

Option 2 forms a particular pattern.

Hence, **option 2** is the correct answer.

**Question 77 :**

Divide Rs 66,300 between A and B in such a way that the amount A receives after 8 years is equal to the amount that B receives after 10 years, with compounded interest being compounded annually a rate of 10% per annum.

**Difficulty : Moderate**

**Average Time : 82 Seconds**

**Options :**

1. A = Rs 36,300, B = Rs 30,000
2. A = Rs 37,000, B = Rs 29,300
3. A = Rs 35,520, B = Rs 30,810
4. A = Rs 35,200, B = Rs 31,100

**Solution :**

The correct answer is **option 1** i.e. **A = Rs 36,300, B = Rs 30,000**

Let the amount given to A be x and B be y.

$$\text{Thus, } x \times (1.1)^8 = y \times (1.1)^{10}$$

$$x/y = 121/100$$

Rs 66300 has to be divided between A and B in a ratio 121:100

Thus, A gets Rs 36,300 and B gets Rs. 30,000

**Question 78 :**

The given bar graph shows the income and expenditure (in crores Rs) of a company over 5 years, from 2014 to 2018. Study the bar graph and answer the question that follows. What is the difference (in cr Rs) between the expenditure for the years 2017 and 2018 taken together and the income for the years 2015 and 2016 taken together?

**Difficulty : Moderate****Average Time : 61 Seconds****Options :**

1. 15
2. 20
3. 16
4. 18

**Solution :**

The correct answer is **option 2** i.e. **20**

Expenditure for the years 2017 and 2018 = 625

Income for the years 2015 and 2016 = 605

Difference = 20



**Question 79 :**

Find the value of the following expression:

**Difficulty : Moderate**
**Average Time : 32 Seconds**
**Options :**

1.  $\frac{13}{114}$
2.  $\frac{49}{114}$
3.  $\frac{1}{6}$
4.  $\frac{107}{34}$

**Solution :**

 The correct answer is **option 3** i.e.  $\frac{1}{6}$ 
**Explanation:**

Solving the numerator, we get

$$\left\{ \frac{3}{2} + \frac{10}{7} \right\} \cdot \left[ \frac{8}{5} \text{ of } \frac{5}{4} \right] - \frac{7}{3}$$

$$\left\{ \frac{3}{2} + \frac{10}{7} \right\} \cdot 2 - \frac{7}{3} = \left\{ \frac{3}{2} + \frac{5}{3} \right\} = \frac{19}{6}$$

Solving the denominator, we get

$$\left\{ \frac{8}{3} - \frac{4}{9} \right\} - \left\{ \frac{5}{6} + 14 \right\}$$

$$\left\{ \frac{8}{3} - \frac{4}{9} \right\} - \left\{ \frac{5}{6} + 14 \right\} = \frac{19}{6} - \left\{ \frac{5}{6} + 14 \right\}$$

19

$$\text{Thus, } \frac{1\frac{1}{2} + 1\frac{3}{7} \div \left(1\frac{3}{5} \text{ of } 1\frac{1}{4}\right) \times 2\frac{1}{3}}{2\frac{2}{3} \div \frac{4}{9} \times \frac{5}{6} + 14} = \frac{\left(\frac{19}{6}\right)}{19} = \frac{1}{6}$$

$$\text{Hence the value of } \frac{1\frac{1}{2} + 1\frac{3}{7} \div \left(1\frac{3}{5} \text{ of } 1\frac{1}{4}\right) \times 2\frac{1}{3}}{2\frac{2}{3} \div \frac{4}{9} \times \frac{5}{6} + 14} \text{ is } \frac{1}{6} .$$

**Question 80 :**

A and B can do a work in 12 days and 18 days, respectively. They worked together for 4 days after which B was replaced by C and the remaining work was completed by A and C in the next 4 days. In how many days will C alone complete 50% of the same work?

**Difficulty : Moderate**
**Average Time : 80 Seconds**

**Options :**

1. 18
2. 21
3. 36
4. 24

**Solution :**

The correct answer is **option 1** i.e. **18**

Let the total work = 36 units

A does 3 units a day and B does 2 units a day.

Thus, A and B do 5 units a day together.

They do 20 units in 4 days. After that 16 units are left which are done by A and C in 4 days.

A and C do 4 units a day.

If A does 3 units a day, C does 1 unit a day.

C does 18 units in 18 days.

**Question 81 :**

A circle is circumscribed on a quadrilateral ABCD. If  $\angle DAB = 100^\circ$ ,  $\angle ADB = 35^\circ$  and  $\angle CDB = 40^\circ$ , then find the measure of  $\angle DBC$ .

**Difficulty : Moderate****Average Time : 55 Seconds****Options :**

1.  $45^\circ$
2.  $40^\circ$
3.  $60^\circ$
4.  $35^\circ$

**Solution :**

The correct answer is **option 3** i.e.  $60^\circ$

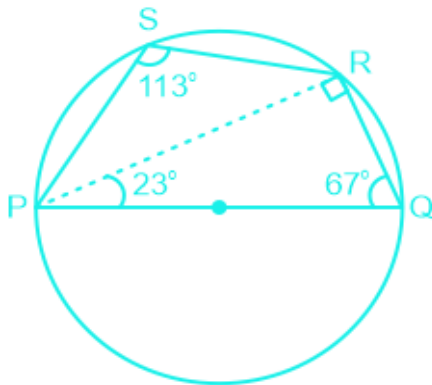

In triangle DAB,

$$\angle DBA + \angle DAB + \angle ADB = 180^\circ$$

$$100^\circ + 35^\circ + \angle DBA = 180^\circ$$

$$\angle DBA = 45^\circ$$

Since the circle is circumscribed on a quadrilateral ABCD, ABCD is a cyclic quadrilateral.

$$\text{So, } \angle ADC + \angle ABC = 180^\circ$$

$$(\angle ADB + \angle CDB) + (\angle ABD + \angle DBC) = 180^\circ$$

$$\angle DBC = 60^\circ$$

The measure of DBC is  $60^\circ$ .

### Question 82 :

The value of  $(\frac{1 - \cot^2 \theta}{1 + \tan^2 \theta})^2 + 1$ , if  $0^\circ < \theta < 90^\circ$ , is equal to:

Difficulty : Moderate

Average Time : 59 Seconds

Options :

1.  $\operatorname{cosec}^2$
2.  $\sin^2$
3.  $\sec^2$
4.  $\cos^2$

Solution :

The correct answer is **option 1** i.e.  $\operatorname{cosec}^2$

$$1 - \cot = (\tan - 1)/\tan$$

$$\left(\frac{1 - \cot}{1 - \tan}\right) = -1/\tan$$

$$\left(\frac{1 - \cot}{1 - \tan}\right)^2 = 1/\tan^2$$

$$\text{And, } 1/\tan^2 = \cot^2$$

$$\text{So, } \cot^2 + 1 = \operatorname{cosec}^2$$

**Question 83 :**

The following bar graph shows the number of youth (in lakhs) and the number of employed youth (in lakhs) in five states A, B, C, D, and E. What is the average number of youth in the five states?

**Difficulty : Moderate****Average Time : 59 Seconds****Options :**

1. 1025000
2. 1010000
3. 1015000
4. 1200000

**Solution :**

The correct answer is **option 2** i.e. **1010000**

Number of youth in five cities (in lakhs) = 50.5

Average number of youth in each state =  $50.5/5 = 10.1$  lakhs or 1010000

**Question 84 :**

The performance of 1800 students in grades has been shown in the following pie chart. How many more students have obtained grade B than those who have obtained grade C?

**Difficulty : Moderate****Average Time : 39 Seconds****Options :**

1. 50
2. 54
3. 3

60

**Solution :**

The correct answer is **option 2** i.e. **54**

Number of students have obtained grade B than those who have obtained grade C = 27% of 1800 - 24% of 1800

$$3\% \text{ of } 1800 = (3/100) \times 1800 = 3 \times 18 = 54$$

**Question 85 :**

A ladder of length 3.5m just reaches the top of a wall. If the ladder makes an angle of 60° with the wall, then what is the height of the wall (in m)?

**Difficulty : Moderate**

**Average Time : 43 Seconds**

**Options :**

1. 3.5
2. 7
3. 3.9
4. 1.75

**Solution :**

The correct answer is **option 4** i.e. **1.75**

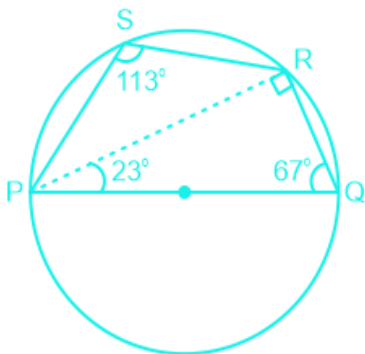

In triangle ABC, B is 90° and ACB = 60°

$$\cos 60^\circ = BC/AC$$

$$BC = \cos 60^\circ \times AC$$

$$BC = (1/2) \times AC = (1/2) \times 3.5$$

BC = 1.75 cm

### Question 86 :

In  $\triangle ABC$ ,  $\angle A = 68^\circ$ . If I is the incentre of the triangle, then measure of  $\angle BIC$  is:

Difficulty : Moderate

Average Time : 50 Seconds

### Options :

1.  $68^\circ$
2.  $56^\circ$
3.  $124^\circ$
4.  $112^\circ$

### Solution :

The correct answer is **option 3** i.e.  $124^\circ$

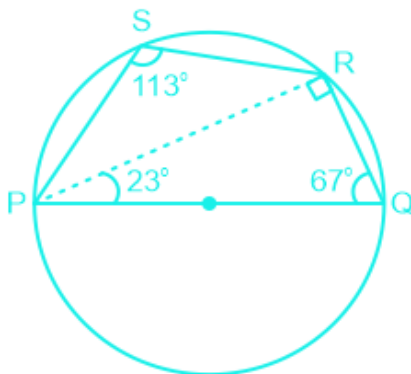

$$\angle BIC = 90^\circ + (\angle BAC/2) = 90 + 68/2$$

$$\angle BIC = 124^\circ$$

### Question 87 :

In a right-angled triangle PQR,  $\angle Q = 90^\circ$ . A and B are the mid-points of PQ and Pr respectively. If  $PQ = 16$  cm, and  $QR = 30$ cm and  $PR = 34$ cm, what is perimeter (in cm) of the trapezium ABRQ?

Difficulty : Moderate

Average Time : 46 Seconds

### Options :

1. 80

40

3. 65

4. 70

**Solution :**

The correct answer is **option 4** i.e. **70**

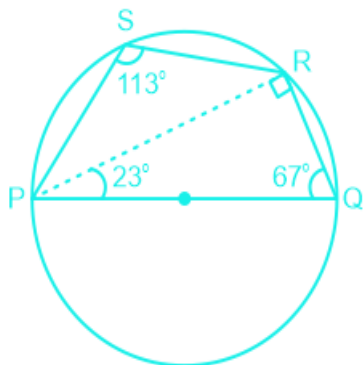

If  $PQ = 16$  cm, then  $AQ = 8$  cm

If  $PR = 34$  cm, then  $BR = 17$  cm and  $AB = 15$  cm

Perimeter of trapezium  $ABRQ = 15 + 17 + 30 + 8 = 70$

**Question 88 :**

The length of the body diagonal of a cube is  $8\sqrt{3}$  cm. What is the volume (in  $\text{cm}^3$ ) of the cube?

Difficulty : Moderate

Average Time : 44 Seconds

**Options :**

1. 216

2. 343

3. 512

4. 729

**Solution :**

The correct answer is **option 3** i.e. **512**

Let the side of the cube =  $a$

$$(3)^{1/2} \times a = 8\sqrt{3}$$



Thus,  $a = 8$

The volume of the cube =  $8^3 = 512$

**Question 89 :**

While preparing the results of English of a class, the marks of one student got recored as 95 in place of 57, as a result of which there was an increase in the average score by 0.95. How many students were here in the class?

**Difficulty : Moderate**

**Average Time : 47 Seconds**

**Options :**

1. 37
2. 45
3. 57
4. 40

**Solution :**

The correct answer is **option 4** i.e. **40**

**Explanation:**

Increase in score of the candidate =  $95 - 57 = 38$

Increase in average = 0.95

Let the number of students =  $n$

$$\frac{38}{n} = 0.95$$

$$n = \frac{38}{0.95} = 40$$

Hence the number of students in the class are 40.

**Question 90 :**

A person bought a book at a 31% discount on its printed price. If no discount was given, then he would have to pay Rs 2,480 more. How much did he pay (in Rs) for the book?

**Difficulty : Moderate**

**Average Time : 51 Seconds**

**Options :**

1. 4560
2. 8000





7000

4. 5520

**Solution :**

The correct answer is **option 4** i.e. **5520**

Let's assume the MP of the book = 100

Discount on the book = 31%

After 31% discount the the price of the book = Rs 69

According to the question,

$$100 - 69 = 2480$$

$$31 = 2480$$

$$1 = 80$$

So, the price of the book =  $80 \times 69 = \text{Rs } 5520$

**Question 91 :**

PQRS is a cyclic quadrilateral and PQ is the diameter of the circle. If  $\angle RPQ = 23^\circ$ , then what is the measure of  $\angle PSR$ ?

**Difficulty : Moderate**

**Average Time : 48 Seconds**

**Options :**

1.  $157^\circ$

2.  $113^\circ$

3.  $123^\circ$

4.  $147^\circ$

**Solution :**

The correct answer is **option 2** i.e.  $113^\circ$

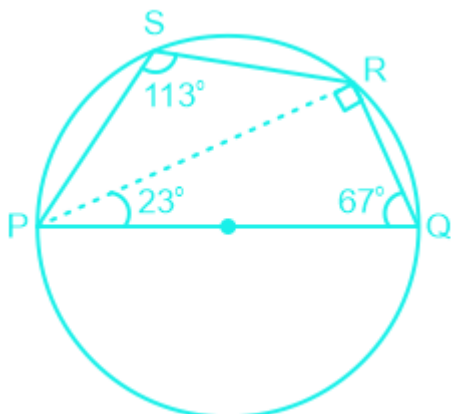

If PQ is the diameter, then  $\angle PRQ = 90^\circ$  (Angle made by a diameter in a segment is  $90^\circ$ )

$$\angle PQR = 180 - 90 - 23 = 67^\circ$$

In a cyclic quadrilateral, Opposite angles are supplementary.

$$\text{Thus, } \angle PQR + \angle PSR = 180$$

$$\angle PSR = 180 - 67 = 113^\circ$$

### Question 92 :

If  $5(\sqrt{3} + \sqrt{75}) = 17.32$ , then the value of  $14(\sqrt{3} + \sqrt{108})$  is:

Difficulty : Moderate

Average Time : 51 Seconds

### Options :

1. 32.46
2. 33.86
3. 34.64
4. 35.64

### Solution :

The correct answer is **option 3** i.e. **34.64**

$$5(\sqrt{3} + \sqrt{75}) = 17.32 \quad 5(3)^{1/2} + 5(3)^{1/2} = 17.32$$

$$\text{So, } 10(3)^{1/2} = 17.32$$

$$14(\sqrt{3} + \sqrt{108}) = 14(3)^{1/2} + (36 \times 3)^{1/2}$$

$$14(\sqrt{3} + \sqrt{108}) = 14(3)^{1/2} + 6(3)^{1/2} = 20(3)^{1/2}$$



$$\text{So, } 20(3)^{1/2} = 2 \times 10(3)^{1/2} = 2 \times 17.32 = 34.64$$

**Question 93 :**

Three partners shared the profit in a business in the proportion of 9 : 8 : 11. They invested their capitals for 4 months, 6 months and 18 months, respectively. What is the ratio of their capitals?

**Difficulty : Moderate****Average Time : 56 Seconds****Options :**

1. 27 : 16 : 66
2. 81 : 16 : 66
3. 81 : 48 : 22
4. 27 : 48 : 22

**Solution :**

The correct answer is **option 3** i.e. **81 : 48 : 22**

**Explanation:**

Let the capital invested be P, Q and R.

Given,  $4P : 6Q : 18R = 9 : 8 : 11$

Equating  $4P = 9$   $P = \frac{9}{4}$

Similarly,  $Q = \frac{8}{6}$  and  $R = \frac{11}{18}$

Thus,  $P : Q : R = \frac{9}{4} : \frac{8}{6} : \frac{11}{18}$

Or,  $P : Q : R = \frac{9}{4} \times 36 : \frac{8}{6} \times 36 : \frac{11}{18} \times 36$

Thus,  $P : Q : R = 81 : 48 : 22$

**Question 94 :**

Which of the following is the smallest number that is a perfect square and is divisible by each of the numbers 6, 8, and 15?

**Difficulty : Moderate****Average Time : 54 Seconds****Options :**

1. 121



576

3. 225

4. 3600

**Solution :**

The correct answer is **option 4** i.e. **3600**

$LCM(6, 8, \text{ and } 15) = 120$

Thus, the number will be in the form of  $120k$  where  $k$  is any natural number.

From the given options, only 3600 is a number divisible by 120.

**Question 95 :**

An article is sold at a certain price. If it is sold at 70% of this price, then there is a loss of 10%. What is the percentage profit, when it is sold at the original selling price?

**Difficulty : Moderate****Average Time : 45 Seconds****Options :**1.  $\frac{300}{7}\%$ 2.  $\frac{200}{7}\%$ 3.  $\frac{100}{7}\%$ 4.  $\frac{50}{7}\%$ **Solution :**

The correct answer is **option 2** i.e.  $\frac{200}{7}\%$

Suppose the article is sold for Rs 100

If it is sold at 70% of the original Selling price, the new SP will be Rs 70

If it is sold for 70, there is a loss of 10%

The Cost Price =  $(100/90) \times 70 = 700/9$

if it sold for Rs 100, then the profit% is equal to

$$\text{profit \%} = \left[ \frac{100 - 700/9}{700/9} \right] \times 100$$

$$(200/700) \times 100 = \frac{200}{7}\%$$

**Question 96 :**



if  $(4a - 3b) = 1$ ,  $ab = \frac{1}{2}$ , where  $a > 0$  and  $b > 0$ , what is the value of  $(64a^3 + 27b^3)$ ?

Difficulty : Moderate

Average Time : 60 Seconds

Options :

1. 25

2. 15

3. 35

4. 30

Solution :

The correct answer is **option 3** i.e. **35**

$$(4a - 3b)^2 = (4a + 3b)^2 - 4 \times 4a \times 3b$$

$$(4a + 3b)^2 = (4a - 3b)^2 + 4 \times 4a \times 3b$$

$$(4a + 3b)^2 = 1 + 48 \times \frac{1}{2} = 1 + 24$$

$$(4a + 3b)^2 = 25 \text{ or } (4a + 3b) = 5$$

$$\text{Now, } (4a + 3b)^3 = 64a^3 + 27b^3 + 3 \times 4a \times 3b \times (4a + 3b)$$

$$5^3 = 64a^3 + 27b^3 + 36 \times \left(\frac{1}{2}\right) \times 5$$

$$64a^3 + 27b^3 = 125 - 90 = 35$$

Question 97 :

if  $a + b + c = 6$ ,  $a^2 + b^2 + c^2 = 32$ , and  $a^3 + b^3 + c^3 = 189$ , then the value of  $4abc$  is:

Difficulty : Moderate

Average Time : 68 Seconds

Options :

1. 8

2. 12

3. 9

4. 16

Solution :



The correct answer is **option 2** i.e. **12**

$$\text{We know, } (a + b + c)^2 = a^2 + b^2 + c^2 + 2(ab + bc + ac)$$

$$2(ab + bc + ac) = 36 - 32 = 4$$

$$(ab + bc + ac) = 4/2 = 2$$

$$\text{We know, } (a + b + c)(a^2 + b^2 + c^2 - (ab + bc + ac)) = a^3 + b^3 + c^3 - 3abc$$

$$6 \times (32 - 2) = 189 - 3abc$$

$$3abc = 189 - 180 = 9$$

$$abc = 3$$

Thus,  $4abc = 12$

**Question 98 :**

A is 25% more than B, and B is 40% less than C. If C is 20% more than D, then A is what percentage less than D?

**Difficulty : Moderate**

**Average Time : 58 Seconds**

**Options :**

1. 9%
2. 12%
3. 10%
4. 11%

**Solution :**

The correct answer is **option 3** i.e. **10%**

**Explanation:**

Let the value of D be 100, then C will be 120

If C is 120, then B will be 72 and A will be 125% of B i.e. 90

Thus, A is 10% less than D

**Question 99 :**

The distance between the two towns is covered in 7 hours at a speed of 50km/h. By how much should the speed (in km/h) be increased so that 2 hours of traveling time will be saved?



Difficulty : Moderate

Average Time : 47 Seconds

Options :

1. 70

2. 20

3. 30

4. 40

Solution :

The correct answer is **option 2** i.e. **20**.

Given:

Speed = 50 Km/h

Time = 7 hours

Explanation:

If we have to save 2 hours, we will have to cover the entire journey in 5 hours.

The ratio of time becomes 5 : 7

Then, the ratio of speed becomes 7 : 5

Thus, the speed must be  $(7/5) \times 50 = 70$  km/h

Hence, Speed should be increased by 20 km/h.

Question 100 :

The number of cars passing the road near a colony from 6 am to 12 am has been shown in the following histogram. During which hour(s) is the number of cars passed less than the average number of cars passed from 7 am to 12 noon?

Difficulty : Moderate

Average Time : 58 Seconds

Options :

1. 6-7, 10-11, 11-12

2. 10-11, 11-12

3. 6-7, 11-12

7-8, 8-9, 9-10

**Solution :**

The correct answer is **option 1** i.e. **6-7, 10-11, 11-12**

Number of cars parked from 7 am to 12 pm = 490

The average number of cars parked between 7 am and 12 pm =  $490/5 = 98$

We can see from the graph that the number of cars parked from 6 - 7, 10 - 11, 11 - 12 are less than 98.

## Ssc Cgl Tier I Previous Year Question Paper Analysis

The analysis of Ssc Cgl Tier I Previous Year Question Paper held on 2022-04-20 in the Evening exam is as follows:

1. 100 questions were moderate.
2. The safe score is 140 marks.
3. 25 questions were asked from English Language, 25 questions were asked from Quantitative Aptitude, 25 questions were asked from Logical Reasoning and 25 questions were asked from General Awareness
4. 17 questions should have been skipped if you were short of time.

## Ssc Cgl Tier I Previous Year Question Paper Topic Wise Weightage

### English Language

1. Cloze Test - 5
2. Spotting Error - 4
3. Parajumbles - 1
4. Idioms - 2
5. One Word Substitution - 2
6. Narration - 1
7. Voice - 2
8. Sentence Improvement - 2
9. Synonym - 2
10. Antonym - 2
11. Filler (Grammar) - 1
12. Incorrectly Spelt - 1



Incorrectly Spelt - 1

## Quantitative Aptitude

1. Comparison Of Quantities - 25

## Logical Reasoning

1. Coding Decoding - 3
2. Analogy - 2
3. Classification - 1
4. Blood Relations - 1
5. Distance And Direction - 1
6. Syllogism - 1
7. Venn Diagrams - 1
8. Dictionary Based - 1
9. Figure Based - 3
10. Matrix - 1
11. Series - 4
12. Mathematical Reasoning - 3
13. Cubes And Dice - 1
14. Seating Arrangement And Puzzle - 2

## General Awareness

1. Geography - 1
2. Art And Culture - 24

# Ssc Cgl Tier I Previous Year Question Paper Tips and Tricks



1. Try to solve Ssc Cgl Tier I Previous Year Question Paper without taking any help from the solutions.
2. Ssc Cgl Tier I Previous Year Question Paper require proper usage of concept so firstly read the question thoroughly and then use the right concept.
3. In case you're not able to solve the question in less than 30 seconds in the exam then you should skip the question and move to the next question.

## Daily Current Affairs



KD Live is providing [Current Affairs](#) on a daily basis for SSC and a [Current Affairs Quiz](#) too for the practice.

## KD Live Free Offerings



KD Live is Offering Every Information and Study Material required for the self study. Please click on the following links for accessing those.

- [Study Plan](#)
- [General Science](#)
- [General Awareness](#)
- [General Knowledge](#)
- [Quantitative Aptitude](#)
- [Logical Reasoning](#)
- [English Language](#)
- [Today In History](#)
- [Syllabus](#)
- [Know Your State](#)
- [Know Your Country](#)
- [Know Your City](#)
- [Know Your Leader](#)
- [Books And Authors](#)
- [Daily Vocabulary](#)
- [Daily Editorial](#)
- [Latest Notifications](#)
- [Exam Dates](#)
- [Admit Card](#)
- [Exam Results](#)
- [Exam Cutoff](#)
- [Exam Eligibility](#)
- [Exam Pattern](#)





[Answer Key](#)  
[Important Days](#)

## Further Guidance on Ssc Cgl Tier I Previous Year Question Paper

For Asking any query on Ssc Cgl Tier I Previous Year Question Paper please mail [Send Email](#) or you can fill the form at [KD Live](#).

### About KD Live

KD live has an expertise in providing apt explanations for the Ssc Cgl Tier I Previous Year Question Paper since 2008. More than 10 lakh aspirants have cleared competitive exams under the guidance of Neetu Mam. Study.kdcampus.live is providing free information on various topics and for the Ssc Cgl Exam you can refer the following link [Click Here](#) however if you want to practice more questions then please refer the following link [Click Here](#).

### About Neetu Mam

Neetu Mam is primarily passionate for the English language and teaching from the last 20 years however for the Ssc Cgl Tier I Previous Year Question Paper. She has guided her team to provide the best explanation for the question.