

Ssc Cgl Tier I Previous Year Question Paper Overview

Here, you can solve all the questions asked in Ssc Cgl Tier I Previous Year Question Paper on 2021-08-24 in the Morning exam. The detailed solutions are also provided for every previous year question and some of these questions can be asked again in your Ssc Cgl Tier I exam. There are 100 questions in the exam and 60 minutes are provided for the Ssc Cgl Tier I exam. The Cutoff of the exam was 140 marks hence you should try to score at least 150 marks.

Ssc Cgl Tier I Previous Year Question Paper : Questions and Solutions

Question 1 :

Sentences of a paragraph are given below in jumbled order. Arrange the sentences in the right order to form a meaningful and coherent paragraph. A. It is also a rich source of news updates around the world. B. Older people and children remain glued to it. C. It has become a great source of entertainment for all. D. TV has become a powerful medium these days.

Difficulty : Moderate

Average Time : 56 Seconds

Options :

1. DBCA
2. ACBD
3. ABCD
4. BDCA

Solution :

The correct answer is **Option 1** i.e. **DBCA**.

While arranging the parts of the passage, we should find some grammatical or contextual connections between them. Also, the first sentence of a passage is usually independent and introduces a topic. The second one provides more information about it.

Steps to arrange the sentences in the correct order to form a meaningful and coherent paragraph:

- Sentence D is the independent sentence as it is talking about how powerful a medium TV has become these days. So, **sentence D** is the first sentence after rearrangement.
- Sentence B further explains that older people and children watch TV all the time. Hence, **sentence B follows**

sentence D.

- **Sentence C** explains because older people and children watch TV a lot, hence, it is a great source of entertainment for them and others. Thus, it should come after sentence B, to maintain continuity on the topic.
- **Sentence A** is the **concluding statement** of the passage.
- Thus, the correct order after rearrangement is **option 1** i.e. **DBCA**.

The paragraph is: **TV has become a powerful medium these days. Older people and children remain glued to it. It has become a great source of entertainment for all. It is also a rich source of news updates around the world.**

Hence, the correct answer is **Option 1** i.e. **DBCA**.

Question 2 :

Select the letter cluster from among the given options that can replace the question mark (?) in the following series.

MEND, PHJZ, SKFV, VNBR, ?

Difficulty : Moderate

Average Time : 103 Seconds

Options :

1. YJYN
2. YQXN
3. YRXO
4. YQZM

Solution :

The correct answer is **option 2** i.e. **YQXN**.

Given series: MEND, PHJZ, SKFV, VNBR, ?

The series follows the pattern:

MEND, PHJZ

$M + 3 = P$

$E + 3 = H$

$N - 4 = J$

$D - 4 = Z$

Similarly,

VNBR, ?



$$V + 3 = Y$$

$$N + 3 = Q$$

$$B - 4 = X$$

$$R - 4 = N$$

So, the next term in the series is **YQXN**.

Question 3 :

In the following diagram, the circle represents 'rural folk', the triangle represents 'businessmen' and the rectangle represents 'graduates'. Study the diagram carefully and answer the question that follows. What is the number of rural businessmen, who are NOT graduates?

Difficulty : Moderate**Average Time : 60 Seconds****Options :**

1. 7
2. 8
3. 15
4. 11

Solution :

The correct answer is **option 2** i.e. **8**.

The number of rural businessmen, who are not graduates = the number that is common to both circle and triangle = 8

Question 4 :

Pointing to a baby girl in a cradle, Sripad said, "She is the daughter of my father's mother's only daughter's elder daughter". How is the baby girl's mother related to Sripad?

Difficulty : Moderate**Average Time : 42 Seconds****Options :**

1. Cousin
2. Aunt
3. Niece
4. Sister-in-law

Solution :

The correct answer is **option 2** i.e. **Aunt**.

In the diagram shown;

Square shows males, the circle shows females, vertical lines show generations, a single horizontal line shows brothers or sisters, and double lines show a couple.

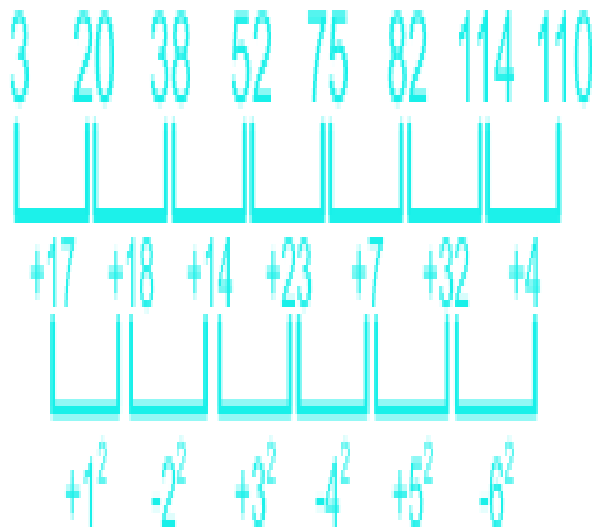

From the above figure, the baby girl's mother is the aunt of Sripad.

Hence, **option 2** is the correct answer.

Question 5 :

Four number-pairs have been given, out of which three are alike in some manner and one is different. Select the number pair that is different.

Difficulty : Moderate

Average Time : 56 Seconds

Options :

1. 28: 163
2. 16: 91
3. 27: 82
4. 22: 127

Solution :



The correct answer is **option 3** i.e. **27: 82**.

The logic used here is:

$$\text{1st number} \times 6 - 5 = \text{2nd number}$$

Option 1: 28: 163

$$28 \times 6 - 5 = 163$$

This follows the logic.

Option 2: 16: 91

$$16 \times 6 - 5 = 91$$

This follows the logic.

Option 3: 27: 82

$$27 \times 6 - 5 = 157$$

This does not follow the logic.

Hence, **option 3** is the odd one out.

Question 6 :

Select the option in which the numbers are related in the same way as are the numbers of the following set. (12, 14, 143)

Difficulty : Moderate

Average Time : 53 Seconds

Options :

1. (12, 18, 246)

2. (17, 12, 134)

3. (16, 10, 235)

4. (15, 19, 252)

Solution :

The correct answer is **option 4** i.e. **(15, 19, 252)**.

The logic used here is:

(12, 14, 143)

$$(12 - 1) \times (14 - 1) = 11 \times 13 = 143$$

**Option 1: (12, 18, 246)**

$$(12 - 1) \times (18 - 1) = 11 \times 17 = 187$$

This does not follow the logic.

Option 2: (17, 12, 134)

$$(17 - 1) \times (12 - 1) = 16 \times 11 = 176$$

This does not follow the logic.

Option 3: (16, 10, 235)

$$(16 - 1) \times (10 - 1) = 15 \times 9 = 135$$

This does not follow the logic.

Option 4: (15, 19, 252)

$$(15 - 1) \times (19 - 1) = 14 \times 18 = 252$$

This follows the logic.

Hence, **option 4** is the correct answer.

Question 7 :

Select the option in which the numbers are NOT related in the same way as are the numbers of the following set. (64, 91, 118)

Difficulty : Moderate

Average Time : 64 Seconds

Options :

1. (46, 73, 101)
2. (48, 75, 102)
3. (72, 99, 126)
4. (55, 82, 109)

Solution :

The correct answer is **option 1** i.e. (46, 73, 101).

The logic used here is:

(64, 91, 118)

$$91 - 64 = 27$$

$$118 - 91 = 27$$

Option 1: (46, 73, 101)

$$73 - 46 = 27$$

$$101 - 73 = 28$$

This does not follow the logic.

Hence, **option 1** is the odd one out.

Question 8 :

Select the figure from among the given option that can replace the question mark (?) in the following series .

Difficulty : Moderate

Average Time : 45 Seconds

Options :

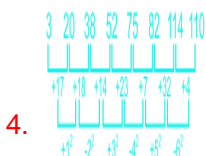
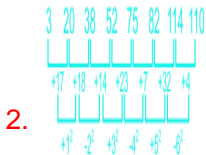
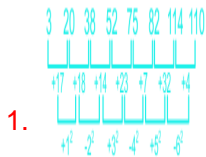

Solution :

The correct answer is **option 3**

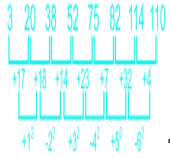

The logic used here is:

1. The letter 'E' moves from the top left side to the bottom right side, then to the bottom left side, then to the middle, and at the last to the right side.
2. The letter 'A' moves from the top right side to the top left side, then to the bottom right side, then to the bottom left side, and at the last to the center.
3. The letter 'O' moves from the bottom right side to the bottom left side, then to the center, then to the top right side, and at the last to the top left side.
4. The letter 'U' moves from the center to the top right side, then to the top left side, then to the bottom right side, and at the last to the bottom left side.
5. The letter 'I' moves from the bottom left side to the middle, then to the top right side, then to the top left side, and at the last to the bottom right side.

The series of figures:



Question 9 :

Which two signs should be interchanged to make the given equation correct? $156 - 13 + 9 \times 18 \div 5 = 169$

Difficulty : Moderate

Average Time : 111 Seconds

Options :

1. \times and $-$
2. \div and $-$
3. \div and $+$
4. \times and \div

Solution :

The correct answer is **option 2** i.e. \div and $-$.



Given equation: $156 - 13 + 9 \times 18 \div 5 = 169$

Let us check all the options:

Option 1: \times and $-$

The expression becomes:

$$= 156 \times 13 + 9 - 18 \div 5 = 169$$

$= 2033.4$ is not equal to 169.

Option 2: \div and $-$

$$= 156 \div 13 + 9 \times 18 - 5 = 169$$

$= 169$ is equal to 169.

As we have found our answer, we need not check the other options.

Hence, **option 2** is the correct answer.

Question 10 :

Akshar and Manvita recently celebrated their silver wedding anniversary and their older son Sanju's birthday. If the age of Sanju is 18 years after his parent's marriage, and his age at their golden anniversary is in the ratio of 5: 21, how many years after their marriage was Sanju born?

Difficulty : Moderate

Average Time : 67 Seconds

Options :

1. 10 years
2. 12 years
3. 15 years
4. 8 years

Solution :

The correct answer is **option 4** i.e. **8 years**.

Let the age of Sanju at their silver anniversary = x years

Sanju's age 7 years before silver anniversary = $(x - 7)$ years

Sanju's age 25 years after silver anniversary = $(x + 25)$ years

According to the question;

$$(x - 7) / (x + 25) = 5 / 21$$

$$x = 17 \text{ years}$$

Sanju's age on silver anniversary = $x = 17$ years

Sanju is born thus 8 years after marriage.

Question 11 :

The sequence of folding a piece of paper and the manner in which the folded paper has been cut is shown in the following figures. How would this paper look when unfolded?

Difficulty : Moderate

Average Time : 58 Seconds

Options :

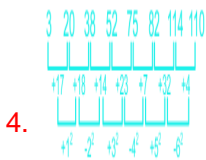
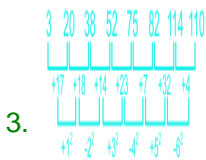
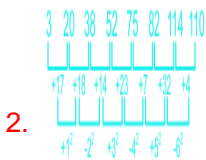
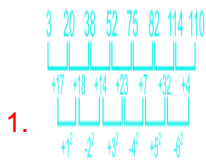

Solution :

The correct answer is **option 3**

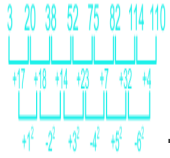

After unfolding, the paper will appear as follows:

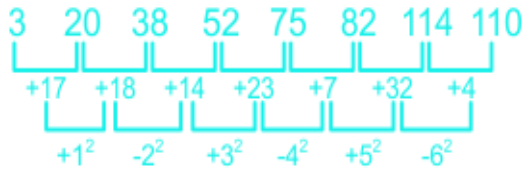

Question 12 :

Select the correct mirror image of the given combination when the mirror is placed at 'PQ' as shown.

Difficulty : Moderate

Average Time : 65 Seconds

Options :

- 1.
- 2.
- 3.
- 4.

Solution :

The correct answer is **option 3** i.e.



The mirror image of the question figure is shown below:



Since the mirror is placed right to the question figure, the right-hand side of the original image will be now the left-hand side of the mirror image.

Hence, **option 3** is the correct answer.

Question 13 :

Select the combination of letters that when sequentially placed in the blanks of the given series will complete the series. r _ v q l _ m v _ l r m _ q _ r m _ q l

Difficulty : Moderate

Average Time : 80 Seconds

Options :

1. l, m, q, r, v, v
2. v, v, q, r, l, m
3. m, r, q, v, l, v
4. q, r, v, l, v, m

Solution :

The correct answer is **option 3** i.e. **m, r, q, v, l, v**.

The sequence is – K, P, Q, R, D, A, P

Given sequence: r _ v q l _ m v _ l r m _ q _ r m _ q l

Option 1: l, m, q, r, v, v

r l v q l m m v q l r m r q v r m v q l

This does not form a particular pattern.

Option 2: v, v, q, r, l, m

r v v q l v m v q l r m r q l r m m q l

This does not form a particular pattern.

Option 3: m, r, q, v, l, v

r m v q l / r m v q l / r m v q l / r m v q l

Option 3 forms a particular pattern. So, there is no need for checking further options.

Hence, **option 3** is the correct answer.

Question 14 :

Select the option in which the words share the same relationship as that shared by the given pair of words. Tintometer: Colour

Difficulty : Moderate

Average Time : 97 Seconds

Options :



Viscometer: Wind

2. Protractor: Angles

3. Planimeter: Pressure

4. Spirometer: Speed

Solution :

The correct answer is **option 2** i.e. **Protractor: Angles**.

The logic used here is:

Tintometer: Colour

Tintometer is used as the colour measurement instrument widely used throughout the food and drink industry to monitor the colour of edible oils and fats; beer; soft drinks; baking; flour milling; sugars; biscuits and confectionery.

Similarly,

Protractor: Angles

A protractor is a measuring instrument used for measuring angles.

Hence, **option 2** is the correct answer.

Question 15 :

Select the option related to the third word in the same way as the second word is related to the first word. Canada: Ottawa:: Cuba:?

Difficulty : Moderate

Average Time : 56 Seconds

Options :

1. Bern

2. Madrid

3. Havana

4. Oslo

Solution :

The correct answer is **option 3** i.e. **Havana**.

The logic used here is:

Canada: Ottawa



Ottawa is the capital city of Canada.

Similarly,

Cuba:?

Havana is the capital city of Cuba.

Hence, **option 3** is the correct answer.

Question 16 :

In a certain code language, 'COW' is written as 'ZRF' and 'DOG' is written as 'JRG'. How will 'RAT' be written in that language?

Difficulty : Moderate

Average Time : 49 Seconds

Options :

1. XDV
2. WDU
3. UDW
4. VEU

Solution :

The correct answer is **option 2** i.e. **WDU**.

The logic used here is:

'COW' is written as 'ZRF'

First, reverse the given code;

COW = FRZ

C + 3 = F

O + 3 = R

W + 3 = Z

'DOG' is written as 'JRG'

DOG = GRJ

D + 3 = G

$O + 3 = R$

$G + 3 = J$

Similarly,

Code for the word RAT:

$R + 3 = U$

$A + 3 = D$

$T + 3 = W$

$RAT = WDU$

Hence, **option 2** is the correct answer.

Question 17 :

How many triangles are there in the given figure?

Difficulty : Moderate

Average Time : 58 Seconds

Options :

- 1. 13
- 2. 12
- 3. 11
- 4. 10

Solution :

The correct answer is **option 3** i.e. **11**.

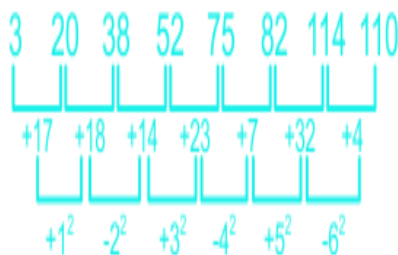

11 triangles: AEB, BEF, ABF, ACD, HGI, KNJ, MNL, KNP, NPJ, MNO, NOL.

Question 18 :

Select the correct option that indicates the arrangement of the given words in the order in which they appear in an English



dictionary. 1. Topology 2. Topper 3. Tolerance 4. Together 5. Tomorrow

Difficulty : Moderate

Average Time : 43 Seconds

Options :

1. 4, 5, 3, 1, 2
2. 4, 2, 3, 1, 5
3. 4, 2, 1, 5, 3
4. 4, 3, 5, 1, 2

Solution :

The correct answer is **option 4** i.e. **4, 3, 5, 1, 2**.

In this question, you need to arrange the words as they would appear in the English dictionary.

So the arrangement is;

1. Together
2. Tolerance
3. Tomorrow
4. Topology
5. Topper

Question 19 :

Select the cubes that can be formed by folding the given sheet along the lines.

Difficulty : Moderate

Average Time : 42 Seconds

Options :

1. Only A and B
2. Only A, B and C
3. Only A,B and D
4. Only B and C

Solution :

The correct answer is **option 1** i.e. **Only A and B**.

When the paper is folded to make a cube;

A is opposite to C.

T is opposite to J.

F is opposite to L.

In figure A, no opposite pairs are adjacent to each other, so, cube A can be formed.

In figure B, no opposite pairs are adjacent to each other, so, cube B can be formed.

In figure C, A and C are adjacent to each other, so, cube C cannot be formed.

In figure D, L and F are adjacent to each other, so, cube D cannot be formed.

Question 20 :

Read the given statements and conclusions carefully. Assuming that the information given in the statements is true, even if it appears to be at variance with commonly known facts, decide which of the given conclusions logically follow(s) from the statements. Statements: All pencils are erasers. Some sharpeners are pencils. Conclusions: I. Some sharpeners are erasers. II. All pencils are sharpeners.

Difficulty : Moderate

Average Time : 78 Seconds

Options :

1. Neither conclusion I nor II follows
2. Both conclusions I and II follow
3. Only conclusion II follows
4. Only conclusion I follows

Solution :

The correct answer is **option 4** i.e. **Only conclusion I follows.**

The least possible Venn Diagram for the given statements is drawn below:



Conclusions:

I. Some sharpeners are erasers **True** (As all pencils are erasers, some sharpeners are pencils, so, we can say that some



sharpeners are erasers).

II. All pencils are sharpeners **False** (It is possible but no definite conclusion can be drawn).

Hence, **Only conclusion I follows.**

Question 21 :

In a certain code language, 'MINT' is coded as '224' and 'FANCY' is coded as '245'. How will 'CONTOUR' be coded in that language?

Difficulty : Moderate

Average Time : 70 Seconds

Options :

1. 259
2. 301
3. 597
4. 742

Solution :

The correct answer is **option 4** i.e. **742**.

The logic used here is:

'MINT' is coded as '224' and 'FANCY' is coded as '245'

$$\text{MINT} = (13 + 9 + 14 + 20) \times 4 = 224$$

$$\text{FANCY} = (6 + 1 + 14 + 3 + 25) \times 5 = 245$$

Similarly,

Code for the word CONTOUR:

$$\text{CONTOUR} = (3 + 15 + 14 + 20 + 15 + 21 + 18) \times 7 = 742$$

Hence, **option 4** is the correct answer.

Question 22 :

Four letter clusters have been given, out of which three are alike in some manner and one is different. Select the letter cluster that is different.

Difficulty : Moderate

Average Time : 50 Seconds

Options :

- TFKG
- 2. FHWU
- 3. RDMI
- 4. JNCQ

Solution :

The correct answer is **option 2** i.e. **FHWU**.

The logic used here is:

Opposite of 1st letter = 4th letter

Opposite of 2nd letter - 10 = 3rd letter

Option 1: TFKG

Opposite of T = G

Opposite of F - 10 = U - 10 = 11 = K

This follows the logic.

Option 2: FHWU

Opposite of F = U

Opposite of H - 10 = S - 10 = 9 = I

This does not follow the logic.

Hence, **option 2** is the odd one out.

Question 23 :

Select the option figures in which the given figure is embedded (rotation is Not allowed)

Difficulty : Moderate

Average Time : 59 Seconds

Options :

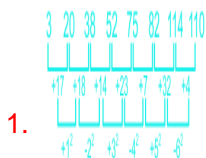

2.

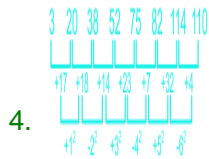
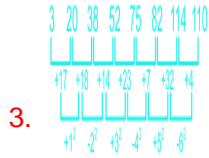
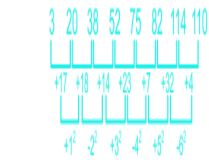

Solution :

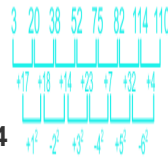

The correct answer is **option 4**.

The given figure is embedded in option 4, as shown below:

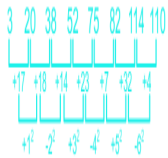

Question 24 :

Select the option that is related to the third number in the same way as the second number is related to the first number.
23: 531:: 27:?

Difficulty : Moderate

Average Time : 67 Seconds

Options :

1. 802
2. 573
3. 731
4. 656

**Solution :**

The correct answer is **option 3** i.e. **731**.

The logic used here is:

23: 531

$$23^2 + 2 = 529 + 2 = 531$$

Similarly,

27:?

$$27^2 + 2 = 729 + 2 = 731$$

Hence, **option 3** is the correct answer.

Question 25 :

Four words have been given, out of which three are alike in some manner and one is different. Select the word that is different.

Difficulty : Moderate

Average Time : 42 Seconds

Options :

1. Myology
2. Dermatology
3. Ecology
4. Ophthalmology

Solution :

The correct answer is **option 3** i.e. **Ecology**.

The logic used here is:

Myology is the study of the muscular system.

Dermatology is the branch of medicine dealing with the skin.

Ecology is the study of the relationships between living organisms.

Ophthalmology is a surgical subspecialty within medicine that deals with the diagnosis and treatment of eye disorders.

Myology, dermatology, and ophthalmology are related to medical fields and ecology is not a medical field.

Hence, **option 2** is the odd one out.

**Question 26 :**

Select the number from among the given options that can replace the question mark (?) in the following series. 3, 20, 38, 52, 75, 82, 114, ?

Difficulty : Moderate

Average Time : 57 Seconds

Options :

1. 104
2. 101
3. 118
4. 110

Solution :

The correct answer is **option 4** i.e. **110**.

Given series: 3, 20, 38, 52, 75, 82, 114, ?

The series follows the pattern:

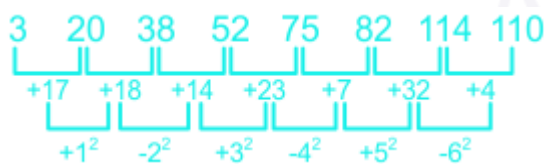

So, the next term in the series is **110**.

Question 27 :

How many brightest stars is the constellation called the Great Bear made up of?

Difficulty : Moderate

Average Time : 43 Seconds

Options :

1. Nine
2. Five
3. Seven
4. Three

Solution :

The correct answer is **option 3** i.e. **Seven**.



- The seven brightest stars in the constellation are called the Great Bear.
- Ursa Major is the largest northern constellation and third largest constellation in the sky.
 - Its brightest stars form the Big Dipper asterism, one of the most recognizable shapes in the sky, also known as the Plough.

Question 28 :

Prophet Muhammad founded the faith of Islam in the _____ century.

Difficulty : Moderate

Average Time : 46 Seconds

Options :

1. sixth
2. eighth
3. seventh
4. ninth

Solution :

The correct answer is **option 3** i.e. **seventh**.

- Prophet Muhammad founded the faith of Islam in the seventh century.
- "Muhammad is the Messenger of Allah".
- Muhammad was born around 570 in the city of Mecca, located on the Arabian Peninsula.

Question 29 :

In which present day state will you find the Megudi temple?

Difficulty : Moderate

Average Time : 43 Seconds

Options :

1. Tamil Nadu
2. Odisha
3. Karnataka
4. Kerala

Solution :

The correct answer is **option 3** i.e. **Karnataka**.



Jain Meguti Temple, one of the shrines belonging to Galaganatha Group of Temples, is situated on a hilltop in Aihole, on a raised platform.

- As per the inscriptions on the temple, this shrine was constructed in 634 AD by Ravikeerthi, a commander and minister of Pulakesin II.
- A huge idol of Lord Mahavira in a sitting posture and partially disfigured yet elegant figure of Goddess Ambika are enshrined inside the temple.

Question 30 :

Through which of the following actions does the lithosphere move over the asthenosphere?

Difficulty : Moderate

Average Time : 54 Seconds

Options :

1. Weathering
2. Continental drift
3. Plate tectonics
4. Deposition

Solution :

The correct answer is **option 3** i.e. **Plate tectonics**.

- Plate tectonics is the theory that Earth's outer shell is divided into large slabs of solid rock, called "plates," that glide over Earth's mantle, the rocky inner layer above Earth's core.
- Earth's solid outer layer, which includes the crust and the uppermost mantle, is called the lithosphere.

Question 31 :

'Ghoomar' is a folk-dance form from the state of _____.

Difficulty : Moderate

Average Time : 48 Seconds

Options :

1. Bihar
2. Jharkhand
3. Rajasthan



Tripura

Solution :

The correct answer is **option 3** i.e. **Rajasthan**.

- Ghoomar is a traditional Rajasthani dance form, in which women twirl round and round in circles as they dance.
- The word 'ghoomar' literally means to twirl in circles, and that gives the name to the dance.
- The popular Ghoomar Dance in Rajasthan India is known to be the characteristic dance of the Bhil tribe.

Question 32 :

Who among the following is one of the authors of 'The Hitman: The Rohit Sharma Story'?

Difficulty : Moderate

Average Time : 50 Seconds

Options :

1. Anupam Kher
2. G Krishnan
3. S Hareesh
4. Sanjana Desai

Solution :

The correct answer is **option 2** i.e. **G Krishnan**.

- The book is written by senior sports journalists, Vijay Lokapally and G. Krishnan & published by Bloomsbury.
- It brings the story of Rohit's journey, his years of hard work and his confidence to fans.
- Rohit is an indisputable star, and recently led the Mumbai Indians to their fifth Indian Premier League title, all of which have come under his captaincy.

Question 33 :

Which Sultan established a separate department (Diwan-i-Amir Kohi) to take care of agriculture?

Difficulty : Moderate

Average Time : 51 Seconds

Options :

1. Jalal-ud-din Khalji
2. Khizr Khan
3. Muhammad Bin Tughlaq
4. Tughril Beg

**Solution :**

The correct answer is **option 3** i.e. **Muhammad Bin Tughlaq**.

- Diwan-i-amir-kohi department related to Agriculture Department was established by Mohammad Bin to improve cultivation. But, it also failed miserably.
- Muhammad bin Tughlaq the eldest son of Ghiyath al-Din Tughluq, was the eighteenth sultan of the Delhi Sultanate.
- He introduced a new coin made of silver, the adlis, and increased the size of the existing gold dinar from 172 grains to 202 grains.

Question 34 :

A/an _____ is a natural geo-hydrological unit of land, which collects water and drains it through a common point by a system of streams.

Difficulty : Moderate**Average Time : 55 Seconds****Options :**

1. watershed
2. aquifer
3. warabandi
4. reservoir

Solution :

The correct answer is **option 1** i.e. **watershed**.

- A watershed is an area of land that drains or “sheds” water into a specific waterbody.
- The watershed collects rain and snowmelt, and delivers it to that body of water.
- Watersheds drain rainfall and snowmelt into streams and rivers.

Question 35 :

Who among the following Indian-American scientists was appointed as the acting chief of staff of the US space agency NASA, in February, 2021?

Difficulty : Moderate**Average Time : 47 Seconds****Options :**

1. Shantanu Narayen
2. Ramesh Raskar
3. Bhavya Lal



Manmohan Attavar

Solution :

The correct answer is **option 3** i.e. **Bhavya Lal**.

- Bhavya Lal Indian-American Bhavya Lal has been appointed as the Acting Chief of Staff of the US space agency by National Aeronautics and Space and Administration (NASA).
- Lal served as a member of the Biden Presidential Transition Agency Review Team for the agency and oversaw the agency's transition under the administration of President Joe Biden.

Question 36 :

Who among the following Indian actresses joined the list of Young Global Leaders (YGL) compiled by the World Economic Forum in March 2021?

Difficulty : Moderate

Average Time : 52 Seconds

Options :

1. Shilpa Shetty
2. Shilpa Shetty
3. Deepika Padukone
4. Alia Bhatt

Solution :

The correct answer is **option 3** i.e. **Deepika Padukone**.

- Actor Deepika Padukone and several Indian citizens joined the list of the Young Global Leaders (YGLs) compiled by the World Economic Forum.
- Deepika Padukone joins a group of Nobel Prize recipients, Pulitzer winners, heads of state and chief executive officers who committed to improving the state of the world.
- The Forum of Young Global Leaders was founded in 2005 by Klaus Schwab, founder and executive chairman of the WEF.

Question 37 :

Which of the following is known as alkaline earth metal?

Difficulty : Moderate

Average Time : 54 Seconds

Options :

Cobalt

2. Platinum

3. Magnesium

4. Copper

Solution :

The correct answer is **option 3** i.e. **Magnesium**.

- The alkaline earth metals (beryllium, magnesium, calcium, strontium, barium, and radium).
- These are the second most reactive metals in the periodic table, and, like the Group 1 metals, have increasing reactivity in the higher periods.
- These metals have relatively low melting points and boiling points, as far as metals are concerned.

Question 38 :

In which of the following countries were the first modern Olympic Games held?

Difficulty : Moderate

Average Time : 47 Seconds

Options :

1. Greece
2. China
3. Spain
4. United Kingdom

Solution :

The correct answer is **option 1** i.e. **Greece**.

1. The first recorded Olympic Games were held at Olympia in the Greek city-state of Elis in 776 B.C.
2. The Games attracted athletes from 14 nations, with the largest delegations coming from Greece, Germany, France, and Great Britain.

Question 39 :

An economy in which both, the private sector and the government are involved is known as a/an _____ economy

Difficulty : Moderate

Average Time : 44 Seconds

Options :

amalgam

2. mixed

3. parallel

4. blended

Solution :

The correct answer is **option 2** i.e. **mixed**.

- A mixed economy consists of both private and government/state-owned entities that share control of owning, making, selling, and exchanging good in the country.
- Mixed economy, in economics, a market system of resource allocation, commerce, and trade in which free markets coexist with government intervention.

Question 40 :

Which of the following places is NOT located on the banks of river Ganga?

Difficulty : Moderate

Average Time : 45 Seconds

Options :

1. Phaphamau
2. Hazaribagh
3. Kanpur
4. Varanasi

Solution :

The correct answer is **option 2** i.e. **Hazaribagh**.

- Hazaribag is not located on the bank of river Ganga.
- The district of Hazaribag is situated in the north east part of North Chotanagpur Division.
- The boundary of this district consists of districts of Gaya (BIHAR) and Koderma in the north, Giridih and Bokaro in the east, Ramgarh in the south and Chatra in the west.

Question 41 :

Who among the following is one of the founder members of Bhartiya Jana Sangh?

Difficulty : Moderate

Average Time : 49 Seconds

Options :



KM Munshi

2. Baldev Singh

3. Shyama Prasad Mukherjee

4. Minoo Masani

Solution :

The correct answer is **option 3** i.e. **Shyama Prasad Mukherjee**.

- Indian politician Syama Prasad Mukherjee was born on July 6, 1901. The youngest ever Vice-Chancellor of Calcutta University and Independent India's first Minister of Industry and Supply.
- Shyama Prasad was a qualified barrister and was passionate about education.
- He came to occupy an important place in national politics, wrote the Vice-President of India M Venkaiah Naidu in The Pioneer.

Question 42 :

As of December 2020, there are _____ official languages of the United Nations.

Difficulty : Moderate

Average Time : 50 Seconds

Options :

1. 10

2. 7

3. 6

4. 11

Solution :

The correct answer is **option 3** i.e. **6**.

- As of December 2020, there are six official languages of the UN. These are Arabic, Chinese, English, French, Russian and Spanish.
- The United Nations is one of the world's largest employers of language professionals.

Question 43 :

Which of the following states became the first one to launch blockchain-enabled solar power trading in December 2020?

Difficulty : Moderate

Average Time : 43 Seconds

Options :



Karnataka

2. Sikkim

3. Madhya Pradesh

4. Uttar Pradesh

Solution :

The correct answer is **option 4** i.e. **Uttar Pradesh**.

- Uttar Pradesh Starts India's First Blockchain-Enabled Rooftop Solar Trading Platform in in December 2020.
- The pilot project is being implemented by Australian company PowerLedger in partnership with India Smart Grid Forum (ISGF), a public private partnership initiative of the power ministry.

Question 44 :

Which of the following companies announced the launch of India's first virtual academy programme Esports Academy?

Difficulty : Moderate

Average Time : 48 Seconds

Options :

1. Asus

2. Jio

3. Samsung

4. Dell

Solution :

The correct answer is **option 1** i.e. **Asus**.

- Asus ROG Academy will be India's first virtual academy program dedicated to gamers.
- ASUS ROG will identify PC gamers through a screening process, providing tournament-ready gaming equipment and high-quality technology to gamers, with professional mentorship.

Question 45 :

Who among the following had invaded India in 712 AD?

Difficulty : Moderate

Average Time : 42 Seconds

Options :



Muhammad Ghori

2. Mahmud of Ghazni

3. Muhammad Bin-Quasim

4. Qutub-ud-Din Aibak

Solution :

The correct answer is **option 3** i.e. **Muhammad Bin-Quasim**.

- The commander of the Umayyad Caliphate, Mohammad Bin Qasim, was the first Muslim to conquer India in 712 AD.
- Muhammad Bin Qasim was known by Laqab 'Imad ad-Din', was 1st Muslim to capture Hindu regions successfully and started the early Muslim Rule.
- Muhammad bin Qasim was born around 695 AD. He belonged to the Saqqafi tribe; that had originated from Taif in Arabia.

Question 46 :

_____ is an economic scenario where a peculiar combination of low growth and rising inflation leads to high unemployment.

Difficulty : Moderate

Average Time : 54 Seconds

Options :

1. Depreciation
2. Deflation
3. Stagflation
4. Recession

Solution :

The correct answer is **option 3** i.e. **Stagflation**.

- Stagflation is an economic condition when stagnant economic growth, high unemployment, and high inflation combine together.
- For example, if there's a sudden, unexpected increase in the price of a commodity like oil, prices surge accordingly while profits drop.

Question 47 :

Coulomb per second is equivalent to _____.



Difficulty : Moderate

Average Time : 42 Seconds

Options :

1. ohm
2. volt
3. ampere
4. joule

Solution :

The correct answer is **option 3** i.e. **ampere**.

- Coulomb per second is equivalent to 'ampere'.
- The coulomb per second is a unit used to measure electric current.
- Coulomb is the SI unit of electric charge which is equal to the amount of charge transported by a current of one ampere in one second.

Question 48 :

Force of attraction between molecules of the same substance is called _____.

Difficulty : Moderate

Average Time : 45 Seconds

Options :

1. viscosity
2. adhesive force
3. surface tension
4. cohesive force

Solution :

The correct answer is **option 2** i.e. **adhesive force**.

- "Adhesive forces" refers to the attractive forces between unlike substance.
- Adhesive force is the force of attraction that exists between the molecules of two different substances.
- It comes under intermolecular interactions.

Question 49 :

Who among the following was the first player from the Indian sub-continent to play for a European Football club (Celtic FC)?



Difficulty : Moderate

Average Time : 46 Seconds

Options :

1. Sailen Manna
2. Pradeep Kumar Banerjee
3. Mohammed Salim
4. Neville D'Souza

Solution :

The correct answer is **option 3** i.e. **Mohammed Salim**.

- Mohammed Salim was an Indian footballer from Calcutta, West Bengal.
- He was best known for his role in the fabled 1930s Mohammedan SC team which claimed five successive Calcutta Football League titles.
- He also became the first player from the Indian sub-continent to play for a European club, Celtic FC.

Question 50 :

'Thullal' is a solo satiric dance form belonging to the state of _____.

Difficulty : Moderate

Average Time : 53 Seconds

Options :

1. Haryana
2. Kerala
3. Arunachal Pradesh
4. Goa

Solution :

The correct answer is **option 2** i.e. **Kerala**.

- Thullal, conceived and composed by the inimitable wordsmith Kalakkath Kunchan Nambiar in the 18th century, is a solo dance and theatre narrative.
- The musical instruments used in this play include Mridangam, Maddalam and Elathalam.



The performer is called as the Thullalkaran.

Question 51 :

_____ is a sessile animal, that relies upon its relationship with plants like algae to build the largest structures of biological origin on earth.

Difficulty : Moderate**Average Time : 48 Seconds****Options :**

1. Bird
2. Mammal
3. Coral
4. Reptile

Solution :

The correct answer is **option 3** i.e. **Coral**.

- Corals are small marine animals made of thin layers of calcium carbonate.
- Coral reefs protect coastlines from storms and erosion, provide jobs for local communities, and offer opportunities for recreation.

Question 52 :

If $a^4 + b^4 + a^2b^2 = 273$ and $a^2 + b^2 - ab = 21$, then one of the values of is :

Difficulty : Moderate**Average Time : 45 Seconds****Options :**

1. $-\sqrt{\frac{9}{4}}$
2. $-\sqrt{\frac{3}{4}}$
3. $\sqrt{\frac{9}{8}}$
4. $\sqrt{\frac{3}{2}}$

Solution :

The correct answer is **option 2** i.e. $-\sqrt{\frac{3}{4}}$

$$a^4 + b^4 + a^2b^2 = 273,$$

$$(a^2)^2 + (b^2)^2 + 2a^2b^2 - a^2b^2 = 273$$

$$(a^2 + b^2)^2 = 273 + a^2b^2 \dots\dots\dots(1)$$

$$a^2 + b^2 - ab = 21$$

$$a^2 + b^2 = 21 + ab \dots\dots\dots(2)$$

On putting the value of eq 2 in eq 1 we get,

$$441 + a^2b^2 + 42ab = 273 + a^2b^2$$

$$42ab = 273 - 441$$

$$ab = -4 \dots\dots\dots(3)$$

$$a^2 + b^2 - ab = 21$$

on adding 2ab on both sides we get,

$$a^2 + b^2 + 2ab = 21 + 3ab$$

$$(a + b)^2 = 21 + 3 \times -4 = 9$$

$$a + b = +3 \text{ and } -3.$$

$$\text{If } a + b = +3 \text{ then } 1/a + 1/b = -3/4.$$

$$\text{If } a + b = -3 \text{ then } 1/a + 1/b = -3/-4 = 3/4.$$

Question 53 :

A train covers 450 km at a uniform speed. If the speed has been 5 km/h more . it would have taken 1 hour less to cover the same distance. How much time will it take to cover 315 km at its usual speed ?

Difficulty : Moderate**Average Time : 96 Seconds****Options :**

1. 7 h 52 m
2. 6 h 30 m
3. 6 h 18 m
4. 7 h

Solution :

The correct answer is **option 4** i.e. **7 h**

Let the speed of the train be 's' km/hr



Time taken by the train to cover 450 km = $450/s$ hr.

If the speed of the train increased by 5 km/hr then time taken by the train reduce by 1 hour.

$$450/(s + 5) = 450/s - 1$$

$$450/s - 450/(s + 5) = 1$$

$$[450(s + 5 - s)]/[s(s + 5)] = 1$$

$$450 \times 5 = s \times (s + 5)$$

$$2250 = s(s + 5) = 45 \times 50$$

On comparing we get,

$$s = 45 \text{ km/hr.}$$

Time taken by the train to cover 315 km = $315/45 = 7$ hours.

Question 54 :

If selling price of 75 articles is equal to cost price of 60 articles, then the approximate loss or gain percent is :

Difficulty : Moderate

Average Time : 59 Seconds

Options :

1. Profit of 25%
2. No profit no loss
3. Loss of 30%
4. Loss of 20%

Solution :

The correct answer is **option 4** i.e. **Loss of 20%**

SP of 75 articles = CP of 60 articles.

SP of 1 articles : CP of 1 articles = $60 : 75 = 4 : 5$.

$$\text{loss\%} = (5 - 4)/5 \times 100 = 20\%.$$

Question 55 :

If p is the third proportional to 3, 9, then what is the fourth proportional to 6, p, 4 ?

Difficulty : Moderate

Average Time : 39 Seconds

**Options :**

1. $\frac{3}{2}$
2. 10
3. 18
4. 23

Solution :

The correct answer is **option 3** i.e. **18**

p is the third proportional to 3, 9

$$3 : 9 :: 9 : p$$

$$3p = 81$$

$$p = 27.$$

Let the fourth proportional be x.

$$6 : 27 :: 4 : x.$$

$$6x = 27 \times 4$$

$$x = 18.$$

Question 56 :

Let $\triangle ABC \sim \triangle RPQ$ and $\frac{AC}{PQ} = \frac{16}{25}$. If $PQ = 4$ cm, $QR = 6$ cm and $PR = 7$ cm, then AC (in cm) is equal to :

Difficulty : Moderate**Average Time : 46 Seconds****Options :**

1. 6
2. 4.8
3. 3.6
4. 7.2

Solution :

The correct answer is **option 2** i.e. **4.8**

$$\frac{\sin A (\cos C + \cos A)}{\cos C (\sin C - \sin A)} = 16/25$$

Then the ratio of their corresponding sides = 4 : 5

$$AB/RP = BC/PQ = AC/RQ.$$

$$AC/6 = 4/5$$

$$AC = 24/5 = 4.8 \text{ cm.}$$

Question 57 :

Study the following table and answer the question: Number of Students Appeared (A) and Passed (P) in an annual examination from four schools, Q, R, S & T in five years (2014 to 2018)

School/ Year	Q	R	S	T	A	P	A	P	A	P	A	P																																
2014	320	240	400	340	420	273	250	225	2015	400	320	380	285	350	280	300	228	2016	440	286	360	288	330	264	320	256	2017	350	252	420	294	380	247	350	315	2018	375	320	450	405	400	344	375	300

The total number of students who passed from school S in 2014 and 2017 is what percent of 90% of the total number of students who appeared from school T in 2015,2016 and 2017? (correct to one decimal place).

Difficulty : Moderate

Average Time : 60 Seconds

Options :

- 53.9
- 54.8
- 59.6
- 57.4

Solution :

The correct answer is **option 3** i.e. **59.6**

The total number of students who passed from school S in 2014 and 2017 = 273 + 247 = 520

The total number of students who appeared from school T in 2015, 2016 and 2017 = 970

90% of 970 = 873.

Required % = (520)/873 × 100 = 59.6%

Question 58 :

The sum of 3-digit numbers abc,cab and bca is not divisible by :

Difficulty : Moderate**Average Time : 39 Seconds****Options :**

1. 37
2. 3
3. 31
4. $a + b + c$

Solution :

The correct answer is **option 3** i.e. **31**

$$abc = 100a + 10b + c \dots\dots\dots(1)$$

$$cab = 100c + 10a + b \dots\dots\dots(2)$$

$$bca = 100b + 10c + a \dots\dots\dots(3)$$

On adding all equations we get,

$$111a + 111b + 111c$$

$$= 111(a + b + c)$$

$$= 3 \times 37 \times (a + b + c).$$

So one can say that the number must be divisible by 3, 37 and $(a + b + c)$.

Question 59 :

A customer wanted to purchase an item marked for Rs10000. Shopkeeper offered two types of discounts, 25% flat discount or successive discounts of 14 % and 12%. Which is the better offer for the customer and by how much?

Difficulty : Moderate**Average Time : 52 Seconds****Options :**

1. first offer by Rs68
2. second offer by Rs68
3. first offer by Rs32
4. second offer by Rs100

Solution :

The correct answer is **option 1** i.e. **first offer by Rs68**

MP = Rs 10000.

Discount = $10000 \times 25/100 = 2500$.

Successive discount of 14% and 12%.

$= -14 - 12 + [(-14) \times (-12)]/100$

$= -26 + 1.68 = -24.32\%$.

24.32% of 10000 = 2432.

Hence one can say that the first offer is beneficial for customers by Rs 68.

Question 60 :

If $\tan \theta + 3\cot \theta - 23 = 0$, $0^\circ < \theta < 90^\circ$, then what is the value of $(\operatorname{cosec}^2 \theta + \cos^2 \theta)$?

Difficulty : Moderate

Average Time : 50 Seconds

Options :

1. $\frac{2}{3}$
2. $\frac{19}{12}$
3. $\frac{14}{3}$
4. $\frac{11}{12}$

Solution :

The correct answer is **option 2** i.e. $\frac{19}{12}$

$$\tan \theta + 3\cot \theta - 23 = 0,$$

$$\frac{\sin \theta}{\cos \theta} + 3\frac{\cos \theta}{\sin \theta} = 23$$

$$\sin^2 \theta + 3\cos^2 \theta = 23\sin \theta \cos \theta$$

$$(\sin \theta - 3\cos \theta)^2 = 0$$

$$\sin \theta = 3\cos \theta$$

$$\tan \theta = \tan 60^\circ$$

$$\theta = 60^\circ.$$

$$\operatorname{cosec}^2 + \cos^2 = \operatorname{cosec}^2 60 + \cos^2 60$$

$$= 4/3 + 1/4 = 19/12.$$

Question 61 :

ABCD is a cyclic quadrilateral such that when sides AB and DC are produced, they meet at E, and sides AD and BC meet at F, when produced. If $\angle ADE = 80^\circ$ and $\angle AED = 50^\circ$, then what is the measures of $\angle AFB$

Difficulty : Moderate

Average Time : 91 Seconds

Options :

1. 40°
2. 20°
3. 50°
4. 30°

Solution :

The correct answer is **option 4** i.e. 30°

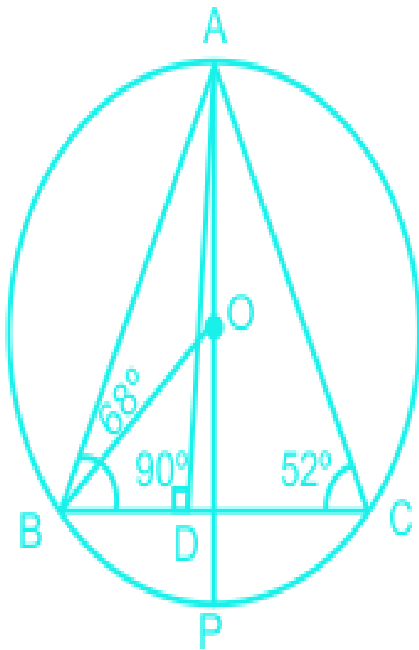

$\angle ADC + \angle ABC = 180^\circ$ (Sum of opposite angle of a cyclic quadrilateral will be equal to 180)

$$ABC = 180 - 80 = 100^\circ.$$

In triangle AED,

$$ADE + DEA + DAE = 180^\circ$$

$$80 + 50 + DAE = 180$$

$$DAE = 50^\circ.$$

Now in triangle ABF,

$$AFB = 180 - ABF - BAF$$

$$= 180 - 100 - 50$$

$$= 30^\circ.$$

Question 62 :

In $\triangle ABC$, right-angled at B, if $\cot A = \frac{1}{2}$, then the value of is:

Difficulty : Moderate

Average Time : 58 Seconds

Options :

1. 3

2. -3

3. -2

4. 2

Solution :

The correct answer is **option 2** i.e. -3

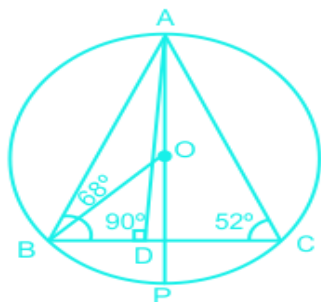

$$\cot A = \frac{1}{2} = \frac{B}{P}$$

$$\text{Hypotenuse} = \sqrt{2^2 + 1^2} = \sqrt{5}.$$

$$\sin A = \frac{2}{\sqrt{5}}$$

$$\cos C = \frac{2}{\sqrt{5}}$$

$$\sin C = \frac{1}{\sqrt{5}}$$

$$\cos A = \frac{1}{\sqrt{5}}$$

$$\frac{\sin A (\cos C + \cos A)}{\cos C (\sin C - \sin A)} = \frac{[\frac{2}{\sqrt{5}}](\frac{2}{\sqrt{5}} + \frac{1}{\sqrt{5}})}{[\frac{2}{\sqrt{5}}](\frac{1}{\sqrt{5}} - \frac{2}{\sqrt{5}})}$$

$$= \frac{(6/5)}{(-2/5)}$$

$$= -3.$$

Question 63 :

The area of a table top in the shape of an equilateral triangle is 93 cm². What is the length (in cm) of each side of the table?

Difficulty : Moderate

Average Time : 73 Seconds

Options :

- 1. 6
- 2. 2
- 3. 4
- 4. 3

Solution :

The correct answer is **option 1** i.e. **6**

$$\text{Area of an equilateral triangle} = \frac{3}{4} \times \text{side}^2$$

$$93 = \frac{3}{4} \times \text{side}^2$$

Side of the triangle = 6 cm.

Question 64 :

Study the following table and answer the question: Number of Students Appeared (A) and Passed (P) in an annual examination from four schools Q, R, S & T in five years (2014 to 2018)

School/Year	Q	R	S	T	A	P	A	P	A	P
2014	320	240	400	340	420	273	250	225	2015	400
2015	400	320	380	285	350	280	300	228	2016	440
2016	440	286	360	288	330	264	320	256	2017	350
2017	350	252	420	294	380	247	350	315	2018	375
2018	375	320	450	405	400	344	375	300		

The difference between the average number of students who passed from school R in 2015 to 2017 and the number of students who passed from school Q in 2015 is x.



the value of x lies between :

Difficulty : Moderate

Average Time : 66 Seconds

Options :

1. 20 and 25
2. 35 and 40
3. 30 and 35
4. 25 and 30

Solution :

The correct answer is **option 3** i.e. **30 and 35**

The average number of students who passed from school R in 2015 to 2017 = $(285 + 294)/2 = 289.5$

The average number of students who passed from school Q in 2015 = 320

Required difference = $320 - 289.5 = 30.5$.

Question 65 :

The table shows the number of trees planted in 4 cities from 2016 to 2020. Years Chandigarh Ahmadabad Pune Kolkata
2016 1800 2500 1800 2000 2017 2500 2300 1850 1800 2018 2300 2400 1840 1760 2019 2440 1950 1900 1600 2020
2250 2100 2000 1750 What is the total number of trees planted in Chandigarh in 2017 and in Kolkata in 2020?

Difficulty : Moderate

Average Time : 45 Seconds

Options :

1. 4500
2. 4750
3. 4250
4. 3550

Solution :

The correct answer is **option 3** i.e. **4250**

The total number of trees planted in Chandigarh in 2017 and in Kolkata in 2020 = $2500 + 1750 = 4250$.

Question 66 :

The vertices of an $\triangle ABC$ lie on a circle with centre O. AO is produced to meet the circle at the point P. D is a point on

BC such that AD ⊥ BC. If B = 68°, C = 52°, then the measures of ∠DAP is :

Difficulty : Moderate

Average Time : 45 Seconds

Options :

1. 18°
2. 16°
3. 12°
4. 28°

Solution :

The correct answer is **option 2** i.e. **16°**

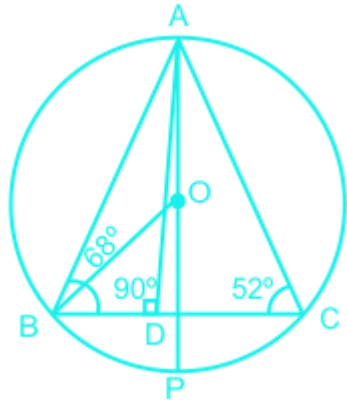

$$\angle BOA = 2 \times 52 = 104^\circ.$$

Now in $\triangle ABD$,

$$68 + 90 + \angle BAD = 180$$

$$\angle BAD = 180 - 90 - 68 = 22^\circ$$

Here $OA = OB$ so $\angle OAB = \angle OBA$

$$\angle OAB = (180 - 104)/2 = 38^\circ.$$

$$\angle DAP = 38 - 22 = 16^\circ.$$

Question 67 :

A can complete a work in $11\frac{1}{2}$ days. B is 25% more efficient than A and C is 50% efficient than B. Working together A, B and C will complete the same work



Difficulty : Moderate

Average Time : 55 Seconds

Options :

1. 5 days
2. 4 days
3. 3 days
4. 8 days

Solution :

The correct answer is **option 2** i.e. **4 days**

Let the efficiency of A be 8 units/day.

Efficiency of B = 25% more than A = $8 \times 1.25 = 10$ units/day.

Efficiency of C = 50% of B = $10 \times .5 = 5$ units/day.

Total work = $8 \times 23/2 = 92$ units.

Time taken by them to complete the work together = $92/(8 + 10 + 5) = 92/23 = 4$ days.

Question 68 :

The average of 23 numbers is 51. The average of the first 12 numbers is 49 and the average of the last 12 numbers is 54. If the twelfth number is removed, then the average of the remaining numbers (correct to two decimal places) is :

Difficulty : Moderate

Average Time : 51 Seconds

Options :

1. 53.25
2. 50.45
3. 51.75
4. 52.65

Solution :

The correct answer is **option 2** i.e. **50.45**

The sum of 23 numbers = $23 \times 51 = 1173$.

The sum of the first 12 numbers = $12 \times 49 = 588$.



The sum of the last 12 numbers = $12 \times 54 = 648$

Twelfth number = $588 + 648 - 1173 = 63$.

The sum of the number except the twelfth number = $1173 - 63 = 1110$.

Average of these 22 numbers = $1110/22 = 50.45$.

Question 69 :

The total number of students in a school is 1400, out of which 35% of the students are girls and the rest are boys. If 80% of the boys and 90% of the girls passed in an annual examination, then the percentage of the students who failed is :

Difficulty : Moderate

Average Time : 52 Seconds

Options :

1. 16.5
2. 21.5
3. 17.4
4. 15.8

Solution :

The correct answer is **option 1** i.e. **16.5**

Number of girls = 35% of 1400 = 490.

Number of boys = $1400 - 490 = 910$.

80% of the boys and 90% of the girls passed an annual examination,

Total passed student = 80% of 910 + 90% of 490 = $728 + 441 = 1169$.

Total failed student = $1400 - 1169 = 231$.

% of failed student = $231/1400 \times 100 = 16.5\%$

Question 70 :

If $(x + \frac{1}{x} = 7)$, then $(x^2 + \frac{1}{x^2})$ is equal to :

Difficulty : Moderate

Average Time : 43 Seconds

Options :



47

2. 49

3. 61

4. 51

Solution :The correct answer is **option 1** i.e. **47**

$$x + 1/x = 7$$

On squaring both sides we get,

$$x^2 + 1/x^2 + 2 = 49$$

$$x^2 + 1/x^2 = 49 - 2 = 47.$$

Question 71 :

In a triangles ABC, the length of the side AC is 4 cm more than 2 times the length of the side AB. Length of the side BC is 4 cm less than the three times the length of the side AB. If perimeter of $\triangle ABC$ is 60 cm, than its area (in cm^2) is :

Difficulty : Moderate**Average Time : 48 Seconds****Options :**

1. 150

2. 144

3. 100

4. 120

Solution :The correct answer is **option 4** i.e. **120**Let AB be x cm then BC becomes $2x + 4$ and AC becomes $3x - 4$

Perimeter of ABC = 60

$$x + 2x + 4 + 3x - 4 = 60$$

$$6x = 60$$

$$x = 10.$$



The side of the triangle becomes 10, 24 and 26.

10 - 24 - 26 is a Pythagorean triplet means ABC is a right-angle triangle.

Area of the triangle = $1/2 \times 24 \times 10 = 120 \text{ cm}^2$.

Question 72 :

If $2x + 3y + 1 = 0$, then what is the value of $(8x^3 + 8 + 27y^3 - 18xy)$?

Difficulty : Moderate**Average Time : 49 Seconds****Options :**

1. -7
2. 7
3. -9
4. 9

Solution :

The correct answer is **option 2** i.e. **7**

$$2x + 3y + 1 = 0$$

$$2x + 3y = -1$$

On cubing both sides we get,

$$(8x^3 + 27y^3 + 12xy(2x + 3y)) = -1$$

$$(8x^3 + 27y^3 - 18xy) = -1$$

$$(8x^3 + 27y^3 - 18xy + 8) = 8 - 1$$

$$(8x^3 + 27y^3 - 18xy + 8) = 7.$$

Question 73 :

A sum of Rs 9500 amounts to Rs11495 in 2 years at a certain rate percent per annum, interest compounded yearly. What is the simple interest (in Rs) on the same sum for the same time and double the rate?

Difficulty : Moderate**Average Time : 54 Seconds****Options :**

1. 3990

3420

3. 4560

4. 3800

Solution :

The correct answer is **option 4** i.e. **3800**

$$A = P(1 + r/100)^n$$

$$11495 = 9500(1 + r/100)^2$$

$$11495/9500 = (1 + r/100)^2$$

$$11/10 = 1 + r/100$$

$$1/10 = r/100$$

$$r = 10\%.$$

$$\text{SI on the same sum for the double rate of interest} = (9500 \times 20 \times 2)/100 \\ = 3800.$$

Question 74 :

Table shows income (in Rs) received by 4 employees of a company during the month of December 2020 and all their income sources. Source Amit Suresh Nitin Varun Salary 35000 38500 29000 42000 Arrears 6000 6300 5000 7500 Bonus 1000 1100 1000 1240 Overtime 1800 1950 1400 1500 What is the ratio of salary of Varun to his income other than salary?

Difficulty : Moderate

Average Time : 50 Seconds

Options :

1. 128 : 653

2. 653 : 128

3. 128 : 525

4. 525 : 128

Solution :

The correct answer is **option 4** i.e. **525 : 128**

The ratio of salary of Varun to his income other than salary = 42000: 10240

$$= 525 : 128.$$



Question 75 :

Simplify $(\sec^2\alpha(1+\frac{1}{\csc\alpha}))(1-\frac{1}{\csc\alpha})$

Difficulty : Moderate

Average Time : 33 Seconds

Options :

1. \tan^2
2. \sin^2
3. 1
4. -1

Solution :

The correct answer is **option 3** i.e. 1

$(\sec^2\alpha(1+\frac{1}{\csc\alpha}))(1-\frac{1}{\csc\alpha})$ can be written as,

$$= \frac{1}{\cos^2} \times (1 + \sin)(1 - \sin)$$

$$= \frac{1}{\cos^2} \times \cos^2$$

$$= 1$$

Question 76 :

The value of $3(\frac{5}{4} \div \frac{2}{5} \text{ of } \frac{3}{5} - \frac{8}{5}) \div \frac{2}{5} \text{ of } \frac{4}{5} + (\frac{4}{5}) \div (\frac{2}{5} \div \frac{8}{5} \times \frac{4}{5})$ is :

Difficulty : Moderate

Average Time : 69 Seconds

Options :

1. -37/60
2. -17/60
3. 17/60
4. 36/60

Solution :

The correct answer is **option 1** i.e. -37/60

$$3 \left(\frac{5}{4} \div \frac{2}{5} \text{ of } \frac{3}{5} - \frac{8}{5} \right) \div \frac{2}{5} \text{ of } \frac{4}{5} + \left(\frac{4}{5} \div \left(\frac{2}{5} \div \frac{8}{5} \times \frac{4}{5} \right) \right)$$





It can be written as,

$$16/5 \div 9/2 \text{ of } 16/3 - 1/8 \div 1/2 \text{ of } 1/4 + 1/4 (1/2 \div 1/8 \times 1/4).$$

$$16/5 \div 24 - 1/8 \div 1/8 + 1/4$$

$$16/5 \div 24 - 1 + 1/4$$

$$2/15 - 3/4$$

$$= -37/60.$$

Question 77 :

Sentences of a paragraph are given below in jumbled order. Arrange the sentences in the right order to form a meaningful and coherent paragraph. A. "Buy sweet apples, or none at all", he instructed his servant. B. A rich man sent his servant to an orchard to buy some apples. C. The servant asked, "How am I to know that all of them are sweet if I taste just one?" D. The owner of the orchard said to the servant, "All my apples are sweet. Try one."

Difficulty : Moderate

Average Time : 102 Seconds

Options :

1. ABCD
2. BADC
3. BDAC
4. ACBD

Solution :

The correct answer is **Option 2** i.e. **BADC**.

While arranging the parts of the passage, we should find some grammatical or contextual connections between them. Also, the first sentence of a passage is usually independent and introduces a topic. The second one provides more information about it.

Steps to arrange the sentences in the correct order to form a meaningful and coherent paragraph:

- Sentence B is the independent sentence because it is introducing the subject 'rich man'. So, **sentence B** is the first sentence after rearrangement.
- Sentence A is talking about the instructions given by the rich man to his servant. Hence, **sentence A follows sentence B**.
- **Sentence D** which is talking about the reaction of the servant should come after sentence A, to maintain continuity on the topic.



Sentence C is the **concluding statement** of the passage.

- Thus, the correct order after rearrangement is **option 2** i.e. **BADC**.

The paragraph is: **A rich man sent his servant to an orchard to buy some apples. "Buy sweet apples, or none at all", he instructed his servant. The owner of the orchard said to the servant, "All my apples are sweet. Try one". The servant asked, "How am I to know that all of them are sweet if taste just one?"**

Hence, the correct answer is **Option 2** i.e. **BADC**.

Question 78 :

Select the most appropriate option to fill in the blank. His _____ of the topic was so good that students had few doubts at the end of the class.

Difficulty : Moderate

Average Time : 105 Seconds

Options :

1. qualification
2. qualification
3. picturisation
4. exposition

Solution :

The correct answer is **Option 4** i.e. **exposition**.

The most appropriate word for the given blank is '**exposition**'.

The word '**exposition**' means '**a comprehensive description and explanation of an idea or theory**'.

Hence, the correct answer is **Option 4** i.e. **exposition**.

Question 79 :

Select the most appropriate ANTONYM of the given word. Infirm

Difficulty : Moderate

Average Time : 44 Seconds

Options :

1. strong
2. Weak
3. Frail



Feeble

Solution :

The correct answer is **Option 1** i.e. **Strong**.

- The word '**Infirm**' means '**not physically or mentally strong, especially through age or illness**'.

For example: *She was too elderly and infirm to remain at home.*

- The most appropriate antonym of the given word is '**Strong**' which means '**powerful; having or using great force or control**'.

Hence, the correct answer is **Option 1** i.e. **Strong**.

Question 80 :

Select the most appropriate meaning of the given idiom. The gift of the gab

Difficulty : Moderate

Average Time : 53 Seconds

Options :

1. Writes very well
2. Talks well and persuasively
3. Loves to give gifts
4. Used to grabbing others' gifts

Solution :

The correct answer is **Option 2** i.e. **Talks well and persuasively**.

Idiom '**The gift of the gab**' means '**the ability to speak easily and confidently in a way that makes people want to listen to you and believe you**'.

For example: *She's got the gift of the gab - she should work in sales and marketing.*

Hence, the correct answer is **Option 2** i.e. **Talks well and persuasively**.

Question 81 :

Select the most appropriate ANTONYM of the given word. Sprightly

Difficulty : Moderate

Average Time : 55 Seconds

Options :

1. Energetic

Active

3. Lively

4. Lethargic

Solution :

The correct answer is **Option 4** i.e. **Lethargic**.

- The word '**Sprightly**' means '**energetic and in good health**'.

For example: *He's a sprightly old man of 75.*

- The most appropriate antonym of the given word is '**Lethargic**,' which means '**having little energy; feeling unwilling and unable to do anything**'.

Hence, the correct answer is **Option 4** i.e. **Lethargic**.

Question 82 :

The following sentence has been divided into parts. One of them contains an error. Select the part that contains the error from the given options. The food / in the new eatery / is much best than / the one in RK Puram.

Difficulty : Moderate

Average Time : 60 Seconds

Options :

1. The food
2. is much best than
3. the one in RK Puram
4. in the new eatery

Solution :

The correct answer is **Option 2** i.e. **is much best than**.

- The error lies in option 2 due to the wrong usage of comparative adjectives.
- Comparative adjectives are used to compare differences between the two objects they modify. They are used in sentences where two nouns are compared.
- Therefore, the use of 'much best than' in the sentence should be replaced by '**much better than**' to make it grammatically correct.

The correct sentence is:- **The food in the new eatery is much better than the one in RK Puram.**



Hence, the correct answer is **Option 2** i.e. **is much best than**.

Question 83 :

Select the option that will substitute the underlined part of the given sentence. In case no substitution is needed, select 'No substitution required'. Japan has made important and original contributions inside some fields like photography and electronics.

Difficulty : Moderate

Average Time : 73 Seconds

Options :

1. No substitution required
2. for some field like
3. in some fields like
4. on some field like

Solution :

The correct answer is **Option 3** i.e. **in some fields like**.

- The error lies in underlined part due to the wrong usage of preposition.
- In the above-given sentence, 'in some fields like' will be used instead of 'inside some fields like'.
- It is so because the word 'inside' means that someone or something is physically enclosed in a room, in a box, etc.
- So, when we are speaking about time or location or other situations in which the person or object is not physically enclosed, we need to use the preposition 'in'.

The correct sentence is:- **Japan has made important and original contributions in some fields like photography and electronics.**

Hence, the correct answer is **Option 3** i.e. **in some fields like**.

Question 84 :

Select the most appropriate synonym of the given word. Leverage

Difficulty : Moderate

Average Time : 73 Seconds

Options :

1. Conclusion
2. Weakness



Influence

4. Suggestion

Solution :

The correct answer is **Option 3** i.e. **Influence**.

- The word '**Leverage**' means '**power to influence people and get the results you want**'.
- The most appropriate synonym of the given word is '**Influence**' which means '**to affect or change how someone or something develops, behaves, or thinks**'.

Hence, the correct answer is **Option 3** i.e. **Influence**.

Question 85 :

Select the option that can be used as a one-word substitute for the given group of words. A short rest or sleep taken after lunch

Difficulty : Moderate

Average Time : 53 Seconds

Options :

1. Slumber
2. Leisure
3. Doze
4. Siesta

Solution :

The correct answer is **Option 4** i.e. **Siesta**.

The word '**Siesta**' means '**an afternoon rest or nap, especially one taken during the hottest hours of the day in a hot climate**'.

For example: *Many workers in warmer climates observe siesta during the afternoon, effecting a pause in business hours, and resuming business in the evenings.*

Hence, the correct answer is **Option 4** i.e. **Siesta**.

Question 86 :

Select the option that will improve the underlined part of the given sentence. In case no improvement is needed select 'No improvement required'. A need of an hour is to provide employment to the youth of the country.

Difficulty : Moderate

Average Time : 58 Seconds

**Options :**

1. No improvement required
2. The need in an
3. The need of the
4. The need of an

Solution :

The correct answer is **Option 3** i.e. **The need of the**.

- The error lies in the underlined part.
- The given sentence is referring to a unspecified point of time. Hence, we have to use the definite article 'the' here.
- "Need of the hour" means at an unspecified point in time ("hour"), there is a thing that everybody wants or must have ("need"). While an "hour" usually refers to the point of time that's exactly sixty minutes long, "hour" in this phrase is not the same.
- Instead, we're just referring to an unspecified time frame, and there's no telling when or if that time frame will end.
- Therefore, as per the points mentioned above, we should changed the underlined part to "**The need of the**" to make the sentence grammatically correct.

The correct sentence is:- **The need of the hour is to provide employment to the youth of the country.**

Hence, the correct answer is **Option 3** i.e. **The need of the**.

Question 87 :

Select the INCORRECTLY spelt word.

Difficulty : Moderate

Average Time : 86 Seconds

Options :

1. Haphazard
2. Chandelier
3. Aesthetic
4. Liecnced

Solution :

The correct answer is **Option 4** i.e. **Liecnced**.



The correct word is '**Licence**' which means '**an official document from the government, court, etc. that gives you permission to do, have, or own something**'.

All other words are correctly spelt.

Hence, the correct answer is **Option 4** i.e. **Liecnced**.

Question 88 :

Select the most appropriate option to fill in the blank. The lack of regular academic sessions has meant that in 2020 the country has had the _____ share of students who have attended educational institutions.

Difficulty : Moderate

Average Time : 52 Seconds

Options :

1. lower
2. lowest
3. low
4. last

Solution :

The correct answer is **Option 2** i.e. **lowest**.

- The most appropriate word for the given blank is '**lowest**'.
- We use a superlative to say that a thing or person is the most of a group.
- When we use a superlative adjective ('the tallest student') before the noun, we generally use it with 'the'. This is because there's only one (or one group) of the thing we are talking about.

Hence, the correct answer is **Option 2** i.e. **lowest**.

Question 89 :

Select the option that expresses the given sentence in reported speech. "I live in Mumbai," she said.

Difficulty : Moderate

Average Time : 56 Seconds

Options :

1. She said that she has been living in Mumbai.
2. She said that she had been living in Mumbai.
3. She said that she lived in Mumbai.
4. She says that she was living in Mumbai.

**Solution :**

The correct answer is **Option 3** i.e. **She said that she lived in Mumbai.**

The given sentence is in direct speech, to convert this sentence into indirect speech we need to follow the following points:

- Inverted commas will get omitted and **'that'** will be used.
- In assertive sentences which does not have a direct personal object like in the given sentence, the reporting verb '**said**' remains unchanged.
- In the reporting speech, the pronoun 'I' will be changed to 'she' when converting into indirect speech.
- The reporting speech is in simple present tense. So, converting into indirect speech, the tense will be changed to **simple past tense**.

After following these steps, we got the indirect speech as: **She said that she lived in Mumbai.**

Hence, the correct answer is **Option 3** i.e. **She said that she lived in Mumbai.**

Question 90 :

Select the INCORRECTLY spelt word.

Difficulty : Moderate

Average Time : 80 Seconds

Options :

1. Boasting
2. Evidence
3. Override
4. Ascetic

Solution :

The correct answer is **Option 3** i.e. **Override.**

The correct word is '**Override**' which means '**(of a person who has the necessary authority) to decide against or refuse to accept a previous decision, an order, a person, etc.**'.

All other words are correctly spelt.

Hence, the correct answer is **Option 3** i.e. **Override.**

Question 91 :

Select the option that can be used as a one-word substitute for the given group of words. A corporation made up of a number of different companies that operate in diversified fields

Difficulty : Moderate

Average Time : 52 Seconds



Options :

1. Correlation
2. Conglomerate
3. Agreement
4. Association

Solution :

The correct answer is **Option 2** i.e. **Conglomerate**.

The word '**Conglomerate**' means '**a very large company consisting of several smaller companies or divisions that supply varied products or services**'.

For example: *The way forward was to liberalise the markets dominated by the big conglomerates.*

Hence, the correct answer is **Option 2** i.e. **Conglomerate**.

Question 92 :

Select the most appropriate meaning of the given idiom. Feel at sea

Difficulty : Moderate

Average Time : 48 Seconds

Options :

1. Feel lost or confused
2. Feel seasick
3. Feel angry
4. Feel comfortable while travelling by water

Solution :

The correct answer is **Option 1** i.e. **Feel lost or confused**.

Idiom '**Feel at sea**' means '**to be confused; to be lost and bewildered**'.

For example: *Reading economic theory leaves me feeling at sea.*

Hence, the correct answer is **Option 1** i.e. **Feel lost or confused**.

Question 93 :

Select the most appropriate synonym of the given word. Integrate

Difficulty : Moderate

Average Time : 48 Seconds

Options :

1. Distribute
2. Assimilate
3. Disburse
4. Separate

Solution :

The correct answer is **Option 2** i.e. **Assimilate**.

- The word 'Integrate' means 'to combine two or more things in order to become more effective'.
- The most appropriate synonym of the given word is 'Assimilate' which means 'to become part of a group, country, society, etc., or to make someone or something become part of a group, country, society, etc.'.

Hence, the correct answer is **Option 2** i.e. **Assimilate**.

Question 94 :

Select the option that expresses the given sentence in passive voice. Richard wore a broad belt with shiny buckles.

Difficulty : Moderate

Average Time : 55 Seconds

Options :

1. A broad belt with shiny buckles was worn by Richard.
2. A broad belt with shiny buckles had been worn by Richard.
3. A broad belt with shiny buckles wore Richard.
4. A broad belt with shiny buckles was wear by Richard.

Solution :

The correct answer is **Option 1** i.e. **A broad belt with shiny buckles was worn by Richard**.

Active form: **Richard wore a broad belt with shiny buckles.**

Rules for changing Active form to Passive from:

- Simply exchange the places of the subject and the object. The subject should become the object and vice-versa while changing a sentence from Active to Passive voice or reverse.
- Now, convert the main verb into its past participle or third form while converting from active to passive voice.
- Use the word "by" before the subject in the passive sentence.

Now, the given sentence is in simple past tense. When the active form is in "V2" form then the passive voice should follow



the format "**was/were + V₃**" form.

The passive form will be: **A broad belt with shiny buckles was worn by Richard.**

Hence, the correct answer is **Option 1** i.e. **A broad belt with shiny buckles was worn by Richard.**

Question 95 :

The following sentence has been divided into parts. One of them contains an error. Select the part that contains the error from the given options. The Committee agreed / that small businesses / has been adversely affected / by COVID- 19.

Difficulty : Moderate

Average Time : 99 Seconds

Options :

1. The Committee agreed
2. that small businesses
3. has been adversely affected
4. by COVID-19

Solution :

The correct answer is **Option 3** i.e. **has been adversely affected.**

- The error lies in option 3.
- The noun businesses is a plural noun.
- According to subject-verb agreement, it must take a plural verb.
- Therefore, the use of '**has been adversely affected**' in the sentence should be replaced with '**have been adversely affected**' to make it grammatically correct.

The correct sentence is:- **The Committee agreed that small businesses have been adversely affected by COVID19.**

Hence, the correct answer is **Option 3** i.e. **has been adversely affected.**

Comprehension :

In the following passage, some words have been deleted. Fill in the blanks with the help of the alternatives given. Select the most appropriate option for each blank. Smoking causes mutation in cells leading to cancer. Quitting smoking can help reverse the (1)_____ risk; and it can replenish cells that actually (2)_____ those of a person who has never smoked. The (3)_____ you smoke the more mutations you have. The (4)_____ damage to the cells lining the airway and lungs can (5)_____ to cancers in the lungs, oesophagus, larynx and pharynx.

Question 96 :

Select the most appropriate option to fill in blank no.1.



Difficulty : Moderate

Average Time : 86 Seconds

Options :

1. impossible
2. potential
3. nominal
4. factual

Solution :

The correct answer is **Option 2** i.e. **potential**.

The given blank is talking about the probability of the risk.

From the given options, it is clear that the word '**potential**' which means '**the possibility of something developing or happening in a particular way**' is the most appropriate word for the given blank.

Hence the correct answer is **Option 2** i.e. **potential**.

Comprehension :

In the following passage, some words have been deleted. Fill in the blanks with the help of the alternatives given. Select the most appropriate option for each blank. Smoking causes mutation in cells leading to cancer. Quitting smoking can help reverse the (1)_____ risk; and it can replenish cells that actually (2)_____ those of a person who has never smoked. The (3)_____ you smoke the more mutations you have. The (4)_____ damage to the cells lining the airway and lungs can (5)_____ to cancers in the lungs, oesophagus, larynx and pharynx.

Question 97 :

Select the most appropriate option to fill in blank no.2.

Difficulty : Moderate

Average Time : 73 Seconds

Options :

1. disagree
2. resemble
3. identify
4. differ

Solution :

The correct answer is **Option 2** i.e. **resemble**.



The given blank is talking about the similarity to a person who has never smoked.

From the given options, it is clear that the word '**resemble**' which means '**have a similar appearance to or qualities in common with (someone or something); look or seem like**' is the most appropriate word for the given blank.

Hence, the correct answer is **Option 2** i.e. **resemble**.

Comprehension :

In the following passage, some words have been deleted. Fill in the blanks with the help of the alternatives given. Select the most appropriate option for each blank. Smoking causes mutation in cells leading to cancer. Quitting smoking can help reverse the (1)_____ risk; and it can replenish cells that actually (2)_____ those of a person who has never smoked. The (3)_____ you smoke the more mutations you have. The (4)_____ damage to the cells lining the airway and lungs can (5)_____ to cancers in the lungs, oesophagus, larynx and pharynx.

Question 98 :

Select the most appropriate option to fill in blank no.3.

Difficulty : Moderate

Average Time : 76 Seconds

Options :

1. many
2. much
3. more
4. most

Solution :

The correct answer is **Option 3** i.e. **more**.

The meaning of the phrase '**the more..... the more**' is used for saying that when a particular activity, feeling etc increases, it causes something else to change at the same time.

For example: *The more work you do now, the more free time you'll have this weekend.*

Therefore, the most appropriate word for the given blank is '**more**'.

Hence, the correct answer is **Option 3** i.e. **more**.

Comprehension :

In the following passage, some words have been deleted. Fill in the blanks with the help of the alternatives given. Select the most appropriate option for each blank. Smoking causes mutation in cells leading to cancer. Quitting smoking can help reverse the (1)_____ risk; and it can replenish cells that actually (2)_____ those of a person who has never smoked. The (3)_____ you smoke the more mutations you have. The (4)_____ damage to the cells lining the airway and lungs



can (5)_____ to cancers in the lungs, oesophagus, larynx and pharynx.

Question 99 :

Select the most appropriate option to fill in blank no.4.

Difficulty : Moderate

Average Time : 78 Seconds

Options :

1. incomplete
2. broken
3. constant
4. stable

Solution :

The correct answer is **Option 3** i.e. **constant**.

The given blank is talking about the continuous damage to the cells due to smoking.

From the given options, it is clear that the word '**constant**' which means '**occurring continuously over a period of time**' is the most appropriate word for the given blank.

Hence, the correct answer is **Option 3** i.e. **constant**.

Comprehension :

In the following passage, some words have been deleted. Fill in the blanks with the help of the alternatives given. Select the most appropriate option for each blank. Smoking causes mutation in cells leading to cancer. Quitting smoking can help reverse the (1)_____ risk; and it can replenish cells that actually (2)_____ those of a person who has never smoked. The (3)_____ you smoke the more mutations you have. The (4)_____ damage to the cells lining the airway and lungs can (5)_____ to cancers in the lungs, oesophagus, larynx and pharynx.

Question 100 :

Select the most appropriate option to fill in blank no.5.

Difficulty : Moderate

Average Time : 73 Seconds

Options :

1. seize
2. direct
3. lead

guide

Solution :

The correct answer is **Option 3** i.e. **lead**.

The given blank is talking about the ill- effects of the damage to the lungs.

From the given options, it is clear that the word '**lead**' which means '**to cause someone to do something, especially something bad**' is the most appropriate word for the given blank.

Hence, the correct answer is **Option 3** i.e. **lead**.

Ssc Cgl Tier I Previous Year Question Paper Analysis

The analysis of Ssc Cgl Tier I Previous Year Question Paper held on 2021-08-24 in the Morning exam is as follows:

1. 100 questions were moderate.
2. The safe score is 140 marks.
3. 25 questions were asked from English Language, 25 questions were asked from Logical Reasoning, 25 questions were asked from General Awareness and 25 questions were asked from Quantitative Aptitude
4. 20 questions should have been skipped if you were short of time.

Ssc Cgl Tier I Previous Year Question Paper Topic Wise Weightage

English Language

1. Reading Comprehension - 25

Logical Reasoning

1. Coding Decoding - 2
2. Analogy - 5
3. Classification - 3
4. Blood Relations - 1
5. Syllogism - 1
6. Venn Diagrams - 1
7. Analytical Reasoning - 1

Page No: 68

Follow us on



Address : 1997, Mukherjee Nagar, 110009

Email : online@kdcampus.org

Call : +91 95551 08888

Download the App



- Dictionary Based - 1
- 9. Figure Based - 4
- 10. Series - 3
- 11. Mathematical Reasoning - 2
- 12. Cubes And Dice - 1

General Awareness

- 1. GK Misc - 25

Quantitative Aptitude

- 1. Simplification - 1
- 2. Average - 1
- 3. Percentage - 1
- 4. Data Interpretation - 4
- 5. Time And Work - 1
- 6. Interest - 1
- 7. Ratios And Proportion - 1
- 8. Geometry - 5
- 9. Trigonometry - 3
- 10. Algebra - 4
- 11. Number System - 2
- 12. Profit And Loss - 1



Ssc Cgl Tier I Previous Year Question Paper Tips and Tricks



1. Try to solve Ssc Cgl Tier I Previous Year Question Paper without taking any help from the solutions.
2. Ssc Cgl Tier I Previous Year Question Paper require proper usage of concept so firstly read the question thoroughly and then use the right concept.
3. In case you're not able to solve the question in less than 30 seconds in the exam then you should skip the question and move to the next question.

Daily Current Affairs



KD Live is providing [Current Affairs](#) on a daily basis for SSC and a [Current Affairs Quiz](#) too for the practice.

KD Live Free Offerings



KD Live is Offering Every Information and Study Material required for the self study. Please click on the following links for accessing those.

- [Study Plan](#)
- [General Science](#)
- [General Awareness](#)
- [General Knowledge](#)
- [Quantitative Aptitude](#)
- [Logical Reasoning](#)
- [English Language](#)
- [Today In History](#)
- [Syllabus](#)
- [Know Your State](#)
- [Know Your Country](#)
- [Know Your City](#)
- [Know Your Leader](#)
- [Books And Authors](#)
- [Daily Vocabulary](#)
- [Daily Editorial](#)
- [Latest Notifications](#)
- [Exam Dates](#)
- [Admit Card](#)
- [Exam Results](#)
- [Exam Cutoff](#)
- [Exam Eligibility](#)
- [Exam Pattern](#)



[Answer Key](#)
[Important Days](#)

Further Guidance on Ssc Cgl Tier I Previous Year Question Paper

For Asking any query on Ssc Cgl Tier I Previous Year Question Paper please mail [Send Email](#) or you can fill the form at [KD Live](#).

About KD Live

KD live has an expertise in providing apt explanations for the Ssc Cgl Tier I Previous Year Question Paper since 2008. More than 10 lakh aspirants have cleared competitive exams under the guidance of Neetu Mam. Study.kdcampus.live is providing free information on various topics and for the Ssc Cgl Exam you can refer the following link [Click Here](#) however if you want to practice more questions then please refer the following link [Click Here](#).

About Neetu Mam

Neetu Mam is primarily passionate for the English language and teaching from the last 20 years however for the Ssc Cgl Tier I Previous Year Question Paper. She has guided her team to provide the best explanation for the question.