



# Ibps Clerk Prelims Previous Year Question Paper Overview

Here, you can solve all the questions asked in Ibps Clerk Prelims Previous Year Question Paper on 2023-10-27 in the Morning Shift exam. The detailed solutions are also provided for every previous year question and some of these questions can be asked again in your Ibps Clerk Prelims exam. There are 100 questions in the exam and 60 minutes are provided for the Ibps Clerk Prelims exam. The Cutoff of the exam was 73 marks hence you should try to score at least 83 marks.

## Ibps Clerk Prelims Previous Year Question Paper : Questions and Solutions

### Comprehension :

Directions: What will come in place of question mark (?) in the following question?

### Question 1 :

$$[31331]/11 + 81 + ? = 27$$

Difficulty : Moderate

Average Time : 43 Seconds

### Options :

1. 14
2. 15
3. 16
4. 17
5. 18

### Solution :

The correct answer is **Option 4** i.e. **17**.

$$[{}^3\sqrt{31331}]/11 + 81 + ? = 27$$

By applying the BODMAS rule, we get

$$11/11 + 9 + ? = 27$$

$$1 + 9 + ? = 27$$



$$? = 27 - 10$$

$$? = 17$$

**Comprehension :**

Directions: What will come in place of question mark (?) in the following question?

**Question 2 :**

$$(34 \times 97) \div 276 = 3?$$

Difficulty : Moderate

Average Time : 42 Seconds

**Options :**

1. 4

2. 3

3. 2

4. 1

5. 0

**Solution :**

The correct answer is **Option 5** i.e. **0**.

$$(3^4 \times 9^7) \div 27^6 = 3^?$$

Applying the BODMAS rule,

$$(3^4 \times 9^7) \div 27^6 = 3^?$$

$$(3^4 \times 3^{14}) \div 27^6 = 3^?$$

$$(3^{18}) \div (3^3)^6 = 3^?$$

$$(3^{18}) \div (3^{18}) = 3^?$$

$$3^0 = 3^?$$

$$? = 0$$

**Comprehension :**

Directions: What will come in place of question mark (?) in the following question?

**Question 3 :**

$$(9 \frac{1}{3} + 7 \frac{1}{2}) = ? + 5 \frac{1}{6} + 6 \frac{1}{3}$$

**Difficulty : Moderate****Average Time : 59 Seconds****Options :**

1.  $\frac{4}{3}$
2. 4
3.  $\frac{5}{3}$
4. 5
5. 6

**Solution :**

The correct answer is **Option 3** i.e.  $\frac{5}{3}$ .

$$9\frac{1}{3} + 7\frac{1}{2} = ? + 5\frac{1}{6} + 6\frac{1}{3}$$

Firstly we have to solve mixed fractions,

$$28/3 + 15/2 = ? + 31/6 + 19/3$$

$$28/3 + 15/2 - 31/6 - 19/3 = ?$$

$$(56 + 45 - 31 - 38)/6 = ?$$

$$(101 - 69)/6 = ?$$

$$? = 32/6 = 16/3$$

$$? = \frac{5}{3}$$

**Question 4 :**

A boat travels 35 km upstream and 45 km downstream in 12 hours. The same boat travels 42.5 km upstream and 76.5 km downstream in 17 hours. Find the upstream speed.

**Difficulty : Moderate****Average Time : 52 Seconds****Options :**

1. 7 km/hr
2. 6.5 km/hr
3. 6 km/hr
4. 5 km/hr

**Solution :**

The correct answer is **Option 4** i.e. **5 km/hr.**

Let speed of boat be  $x$  and that of stream be  $y$ .

Downstream speed =  $x + y$

Upstream speed =  $x - y$

According to the question:

$$45/(x + y) + 35/(x - y) = 12$$

$$42.5/(x - y) + 76.5/(x + y) = 17$$

Replace  $1/(x + y) = a$ ,  $1/(x - y) = b$ .

$$45a + 35b = 12$$

$$76.5a + 42.5b = 17$$

After solving these equations,

$$a = 1/9$$

$$b = 1/5$$

$$1/b = x - y = \text{upstream speed} = 5 \text{ km/hr}$$

**Question 5 :**

In the given question, five words are printed in bold and are numbered A, B, C, D and E. The position of some highlighted words may be incorrect and need to be exchanged with another highlighted to make the sentence correct. Find the words that need to be exchanged. In case the given sentence is correct, your answer is option (5) i.e. 'No exchange required.' The razzmatazz for toilet construction/ODF certification has overshadowed (A) the fact that the essence (B) of universal water and sanitation coverage is derived (C) from the right to life, guaranteed (D) by Article 21 of the Constitution.

**Difficulty : Moderate**

**Average Time : 83 Seconds**

**Options :**

1. Both A-D and B-C
2. Only A-B
3. Only B-C
4. Both A-B and C-D

No exchange required

**Solution :**

The correct answer is **Option 5** i.e. **No exchange required.**

Concept/Grammar rules	Applications
The given question asks to find the words that need to be exchanged over one another (the emboldened ones) in order to form a coherent sentence.	The statement is correct in its present form and therefore, no pair of words needs to be replaced in case of the given statement.  Hence, the correct answer is <b>Option 5</b> i.e. <b>No exchange required.</b>

**Question 6 :**

In the following sentence, a part of the sentence is emboldened. Below are given alternatives to the emboldened part, which may improve or replace the meaning of the sentence. Choose the correct alternative. In case no improvement is needed, choose the alternative that indicates 'No improvement.' I was so angry at myself for making such a big mistake.

Difficulty : Moderate

Average Time : 74 Seconds

**Options :**

1. so angry about myself
2. so angry on myself
3. so angry for myself
4. so angry with myself
5. No Improvement

**Solution :**

The correct answer is **option 4**, i.e. **so angry with myself.**

Concept/Grammar Rules	Application
The question seeks for an appropriate representation of the given sentence so as to make it seem both grammatically as well as contextually appropriate.	<p>The sentence will seem appropriate with the application of "with" as the presence of "at" is incorrect."At" is used when someone is angry at "something" and "with" is used as a preposition when someone is angry with "somebody".</p> <p>Hence, the correct sentence will be "I was so angry <b>with</b> myself for making such a big mistake".</p>

**Comprehension :**

Directions: What will come in place of question mark (?) in the following question?

**Question 7 :**

$$4.5 + 23.50 + 14.58 - 17.68 \times 0.5 = ?$$

**Difficulty : Moderate****Average Time : 89 Seconds****Options :**

1. 33.14
2. 33.34
3. 33.54
4. 33.74
5. 33.94

**Solution :**

The correct answer is **Option 4** i.e. **33.74**.

$$4.5 + 23.50 + 14.58 - 17.68 \times 0.5 = ?$$

$$4.5 + 23.50 + 14.58 - 8.84 = ?$$

$$42.58 - 8.84 = ?$$

$$? = 33.74$$

**Comprehension :**

What will come in place of question mark (?) in the following question?

**Question 8 :**

$$27 - [162 - (273 + 281) \div 2] = ?$$

**Difficulty : Moderate**

**Average Time : 38 Seconds**

**Options :**

1. 48

2. 50

3. 52

4. 46

5. 44

**Solution :**

The correct answer is **Option 1** i.e. **48**.

$$27 - [16^2 - (273 + 281) \div 2] = ?$$

Using the BODMAS rule:

$$27 - [256 - 554/2] = ?$$

$$27 - 256 + 277 = ?$$

$$? = 48$$

**Comprehension :**

Directions: What will come in place of question mark (?) in the following question?

**Question 9 :**



$$\{(7.29 \times 2.7) \div 1000\} \times 103 = (?)^3 \times 10^{-3}$$

Difficulty : Moderate

Average Time : 42 Seconds

Options :

1.  $3^3$
2.  $3^2$
3.  $3^1$
4.  $3^0$
5. 0

Solution :

The correct answer is **Option 1** i.e.  $3^3$ .

$$\{(7.29 \times 2.7) \div 1000\} \times 10^3 = (?)^3 \times 10^{-3}$$

$$(?)^3 \times 10^{-6} = \{(19.683) \div 1000\}$$

$$(?)^3 \times 10^{-6} = 19683 \times 10^{-6}$$

$$(?)^3 = 19683$$

$$(?)^3 = (27)^3$$

On comparing both sides

$$? = 27$$

$$? = 3^3$$

Comprehension :

Directions: What will come in place of question mark (?) in the following question?

Question 10 :

$$34.5\% \text{ of } 1800 + 12.4\% \text{ of } 1500 = (?)^2 + 726$$

Difficulty : Moderate

Average Time : 56 Seconds

Options :

1. 3
2. 6



9

4. 12

5. 15

**Solution :**

The correct answer is **Option 3** i.e. **9**.

$$34.5\% \text{ of } 1800 + 12.4\% \text{ of } 1500 = (?)^2 + 726$$

Applying BODMAS Rule;

$$0.345 \times 1800 + 0.124 \times 1500 = ?^2 + 726$$

$$807 = ?^2 + 726$$

$$?^2 = 81$$

$$? = 9$$

**Comprehension :**

Read the following passage, few blanks have been provided which have to be filled according to the options given below in such a manner that they provide grammatical and contextual meaning to the sentences. A man who was the lone survivor of a terrible shipwreck was washed ashore on a tiny uninhabited island. (1)\_\_\_\_\_ and alone, the man cried out to God to rescue him from his terrible fate. Unfamiliar with survival (2)\_\_\_\_\_, the man struggled to (3)\_\_\_\_\_. Eventually, he was able to construct a hut to protect him and his few possessions. Every day the man faithfully scanned the horizon for the answer to his prayer. One day, after (4)\_\_\_\_\_ for food, he arrived home and found his little hut burning to the ground. There was nothing left but ashes and smoke. "God, how could you do this to me!!" He cried. Broken and (5)\_\_\_\_\_ he sobbed himself to sleep. The next day, he was awakened by the sound of a ship. It had come to rescue him. He asked the sailor, "How did you know I was here?" "As we were heading East, we saw your smoke signal," the sailor replied.

**Question 11 :**

Select the most appropriate option to fill in blank no. 4.

Difficulty : Moderate

Average Time : 92 Seconds

**Options :**

1. Collecting
2. Squandering
3. Blowing

## Scavenging

### 5. Wasting

#### Solution :

The correct answer is **option 4 i.e., Scavenging.**

The word “scavenging” means a search for discarded items or food in a place. The word suits here as it is an uninhabited island where the man is struggling to survive.

Hence the chosen option is correct.

#### Comprehension :

Read the following passage, few blanks have been provided which have to be filled according to the options given below in such a manner that they provide grammatical and contextual meaning to the sentences. A man who was the lone survivor of a terrible shipwreck was washed ashore on a tiny uninhabited island. (1)\_\_\_\_\_ and alone, the man cried out to God to rescue him from his terrible fate. Unfamiliar with survival (2)\_\_\_\_\_, the man struggled to (3)\_\_\_\_\_. Eventually, he was able to construct a hut to protect him and his few possessions. Every day the man faithfully scanned the horizon for the answer to his prayer. One day, after (4)\_\_\_\_\_ for food, he arrived home and found his little hut burning to the ground. There was nothing left but ashes and smoke. “God, how could you do this to me!!” He cried. Broken and (5)\_\_\_\_\_ he sobbed himself to sleep. The next day, he was awakened by the sound of a ship. It had come to rescue him. He asked the sailor, “How did you know I was here?” “As we were heading East, we saw your smoke signal,” the sailor replied.

#### Question 12 :

Select the most appropriate option to fill in blank no. 1.

Difficulty : Moderate

Average Time : 105 Seconds

#### Options :

1. Marooned
2. Leave
3. Stored
4. Despaired
5. Gloomy

#### Solution :

The correct answer is **option 1 i.e., Marooned.**

The word “marooned” means to leave someone trapped and alone in an inaccessible place. The sentence is about a

person left alone on an uninhabited island after the shipwreck.

Hence the chosen option is correct.

**Comprehension :**

Read the following passage, few blanks have been provided which have to be filled according to the options given below in such a manner that they provide grammatical and contextual meaning to the sentences. A man who was the lone survivor of a terrible shipwreck was washed ashore on a tiny uninhabited island. (1)\_\_\_\_\_ and alone, the man cried out to God to rescue him from his terrible fate. Unfamiliar with survival (2)\_\_\_\_\_, the man struggled to (3)\_\_\_\_\_. Eventually, he was able to construct a hut to protect him and his few possessions. Every day the man faithfully scanned the horizon for the answer to his prayer. One day, after (4)\_\_\_\_\_ for food, he arrived home and found his little hut burning to the ground. There was nothing left but ashes and smoke. "God, how could you do this to me!!" He cried. Broken and (5)\_\_\_\_\_ he sobbed himself to sleep. The next day, he was awakened by the sound of a ship. It had come to rescue him. He asked the sailor, "How did you know I was here?" "As we were heading East, we saw your smoke signal," the sailor replied.

**Question 13 :**

Select the most appropriate option to fill in blank no. 2.

**Difficulty : Moderate**

**Average Time : 105 Seconds**

**Options :**

1. Ploy
2. Tactics
3. Device
4. Means
5. Game

**Solution :**

The correct answer is **option 2 i.e. Tactics.**

The word "tactics" means an action or strategy carefully planned to achieve a specific end. The sentence is about the tactics to survive on a lone island.

Hence, the chosen option is correct.

**Comprehension :**

Read the following passage, few blanks have been provided which have to be filled according to the options given below in such a manner that they provide grammatical and contextual meaning to the sentences. A man who was the lone survivor of a terrible shipwreck was washed ashore on a tiny uninhabited island. (1)\_\_\_\_\_ and alone, the man cried out to God

to rescue him from his terrible fate. Unfamiliar with survival (2)\_\_\_\_\_, the man struggled to (3)\_\_\_\_\_. Eventually, he was able to construct a hut to protect him and his few possessions. Every day the man faithfully scanned the horizon for the answer to his prayer. One day, after (4)\_\_\_\_\_ for food, he arrived home and found his little hut burning to the ground. There was nothing left but ashes and smoke. "God, how could you do this to me!!" He cried. Broken and (5)\_\_\_\_\_ he sobbed himself to sleep. The next day, he was awakened by the sound of a ship. It had come to rescue him. He asked the sailor, "How did you know I was here?" "As we were heading East, we saw your smoke signal," the sailor replied.

**Question 14 :**

Select the most appropriate option to fill in blank no. 3.

Difficulty : Moderate

Average Time : 104 Seconds

**Options :**

1. Live
2. Endure
3. Stabilize
4. Firm
5. Fade

**Solution :**

The correct answer is **option 2 i.e., Endure.**

The word "endure" means remain in existence. The sentence is about the fact that the man was unfamiliar with the tricks to survive in a lonely island and thus, struggled to exist.

Hence, the chosen option is correct.

**Comprehension :**

Read the following passage, few blanks have been provided which have to be filled according to the options given below in such a manner that they provide grammatical and contextual meaning to the sentences. A man who was the lone survivor of a terrible shipwreck was washed ashore on a tiny uninhabited island. (1)\_\_\_\_\_ and alone, the man cried out to God to rescue him from his terrible fate. Unfamiliar with survival (2)\_\_\_\_\_, the man struggled to (3)\_\_\_\_\_. Eventually, he was able to construct a hut to protect him and his few possessions. Every day the man faithfully scanned the horizon for the answer to his prayer. One day, after (4)\_\_\_\_\_ for food, he arrived home and found his little hut burning to the ground. There was nothing left but ashes and smoke. "God, how could you do this to me!!" He cried. Broken and (5)\_\_\_\_\_ he sobbed himself to sleep. The next day, he was awakened by the sound of a ship. It had come to rescue him. He asked the sailor, "How did you know I was here?" "As we were heading East, we saw your smoke signal," the sailor replied.

**Question 15 :**

Select the most appropriate option to fill in blank no. 5.

Difficulty : Moderate

Average Time : 105 Seconds

**Options :**

1. Daydream
2. Hoped
3. Planned
4. Longed
5. Despaired

**Solution :**

The correct answer is **option 5 i.e., Despaired.**

The word "despaired" means the complete loss or absence of hope. The sentence is about the fact that the person is broken and devoid of any hope and sobbed himself to sleep.

Therefore, the chosen option is correct.

**Question 16 :**

In the following sentence, a part of the sentence is emboldened. Below are given alternatives to the emboldened part, which may improve or replace the meaning of the sentence. Choose the correct alternative. In case no improvement is needed, choose the alternative that indicates "No improvement". There is no more room for new players in this arena.

Difficulty : Moderate

Average Time : 67 Seconds

**Options :**

1. There is no more space
2. No more void is available
3. There is no room
4. There is no more accomodation
5. No Improvement

**Solution :**

The correct answer is **option1 i.e. There is no more space.**

Concept/Grammar rules	Applications
The theme of the question is to find the best alternative for the highlighted word so as to make the sentence both grammatically as well as contextually appropriate.	The given sentence does not talk about any physical space rather it talks about the virtual space that is being set as a limitation. And all options other than option 1 are contextually incoherent with the meaning of the given sentence.  Hence, option 1 is correct.

**Comprehension :**

Directions: What will come in place of question mark (?) in the following question?

**Question 17 :**

$$(8/13) \times (32 \times 78) \div (768/32) = ?$$

**Difficulty : Moderate****Average Time : 85 Seconds****Options :**

1. 64
2. 48
3. 120
4. 96
5. 72

**Solution :**

The correct answer is **Option 1** i.e. **64**.

$$(8/13) \times (32 \times 78) \div (768/32) = ?$$



Applying the BODMAS Rule;

$$(8/13) \times (32 \times 78) \div 24 = ?$$

$$(8/13) \times (2496) \div 24 = ?$$

$$(8/13) \times 104 = ?$$

$$? = 8 \times 8$$

$$? = 64$$

**Comprehension :**

Directions: What will come in place of question mark (?) in the following question?

**Question 18 :**

$$(3375)^{2/3} \times (1/900)^{-1/2} \div (225)^{-1} = (15)^? \times 2$$

Difficulty : Moderate

Average Time : 43 Seconds

**Options :**

1. 2

2. 4

3. 5

4. 3

5. 1

**Solution :**

The correct answer is **Option 3** i.e. **5**.

$$(3375)^{2/3} \times (1/900)^{-1/2} \div (225)^{-1} = (15)^? \times 2$$

$$15^2 \times 30 \div 1/15^2 = (15)^? \times 2$$

Applying BODMAS Rule;

$$15^2 \times 30 \times 15^2 = (15)^? \times 2$$

$$15^5 = (15)^?$$

$$? = 5$$

**Question 19 :**

In the following questions, a statement is divided into 5 different segments. Part (A) in the sentence is fixed and other parts

may not be in the correct sequence. You have to rearrange the other parts of the sentence to make it contextually and grammatically correct and if the correct sequence doesn't match any of the given sequences, mark (5) i.e., "None of the above" as your answer. The nearly 350 senior risk professionals in industries from retail to manufacturing who were surveyed (A)/ 68% identifying a "prolonged global recession" as most likely over the coming 18 months. (B)/for the report fretted most about the economic impact, with (C)/ A surge in bankruptcies and industry failures also featured highly (D)/ as did concern over another COVID-19 outbreak (E).

Difficulty : Moderate

Average Time : 76 Seconds

Options :

1. ABCDE
2. ADBCE
3. ACBDE
4. ADECB
5. None of the Above

Solution :

The correct answer is **option 3 i.e. ACBDE**

Concept/Grammar Rules	Application
-----------------------	-------------



The query is to rearrange the given jumbled parts to form a meaningful sentence.

**The correct sequence is ACBDE:**

The nearly 350 senior risk professionals in industries from retail to manufacturing who were surveyed for the report fretted most about the economic impact, with 68% identifying a “prolonged global recession” as most likely over the coming 18 months. A surge in bankruptcies and industry failures also featured highly as did concern over another COVID-19 outbreak.

Hence, option 3 is correct.

**Question 20 :**

Ram and Shivam together take Rs.1250 for a work and together they can finish that work in  $(50/7)$  days while Shivam and Tina together can do that work together in 10 days. What will be the share of Tina if Tina is 50% more efficient than Shivam and all three persons together start working?

**Difficulty : Moderate**

**Average Time : 75 Seconds**

**Options :**

1. Rs.225
2. Rs.500
3. Rs.375
4. Rs.425

None of these

**Solution :**

The correct answer is **Option 3** i.e. **Rs.375**.

Since Tina is 50% more efficient than Shivam. So, the time taken by Tina and Shivam together to finish that work alone is '3x' and '2x' respectively.

According to the question:

$$(1/3x) + (1/2x) = (1/10)$$

$$5/6x = 1/10$$

$$x = 25/3$$

Now,

$$(1/R) + (1/3x) = (7/50)$$

$$(1/R) = (7/50) - (1/25)$$

$$R = 10$$

The ratio of efficiency of Ram, Shivam, and Tina

$$(1/R) : (1/3x) : (1/2x) = (1/10) : (1/25) : (3/50) = 5 : 2 : 3$$

Hence, share of Tina =  $1250 \times (3/10) = \text{Rs.}375$

**Question 21 :**

In the sentence given below one part is emboldened. The part given in bold may or may not be correct. Select the best alternative among the four given which can replace the part in bold to make the sentence grammatically and contextually correct. If the part given in bold is already correct and does not require any replacement, choose option 5 i.e., "No improvement" as your answer. In Britain, Germanic tribes arrived and settle at the east coast in 5CE.

Difficulty : Moderate

Average Time : 76 Seconds

**Options :**

1. settle on the
2. settled on the
3. settled by the
4. settled at the



No improvement

**Solution :**

The correct answer is **option 2 i.e., Settled on the.**

As there is conjunction i.e., and is used so the tense before and after the conjunction should be the same and the preposition used here should be 'on' as it indicates the position.

The correct sentence will be-

**In Britain, Germanic tribes arrived and settled on the east coast in 5CE.**

**Question 22 :**

A train running with speed 70 km/h can cross another train of  $\frac{1}{3}$ rd length running in opposite direction in 14.4 seconds. If the speed of second train is 56 km/h, then find the time in which they will cross each other running in same directions.

Difficulty : Moderate

Average Time : 72 Seconds

**Options :**

1. 136.6 seconds
2. 129.6 seconds
3. 99.6 seconds
4. 106 seconds
5. None of these

**Solution :**

The correct answer is **Option 2 i.e. 129.6 seconds**

Understanding	Application
---------------	-------------

Suppose the length of 1st train = X m Then, Length of 2nd train = X/3 m	According to the question: When trains are running in opposite directions $(X + X/3) = (70 + 56) \times 5/18 \times 14.4$ $(X + X/3) = 504$ ..... (1)
When trains are running in same directions: Relative speed = $(70 - 56) \times 5/18 = 35/9$ m/s Suppose they cross in T seconds.	So, $(X + X/3) = 35/9 \times T$ From equation 1: $35/9 \times T = 504$ T = 129.6
	Hence, Time in which they will cross each other running in same directions = 129.6 seconds

**Question 23 :**

The ratio of the present age of A and B is 2 : 3. The present age of A is 20 years. Find the age of B after 5 years.

Difficulty : Moderate

Average Time : 77 Seconds

**Options :**

1. 30 years
2. 25 years
3. 40 years

35 years

5. 45 years

**Solution :**

The correct answer is **option 4** i.e. **35 Years**

Understanding	Application
Let the age of A is $2x$ years and the age of B is $3x$ years.	$2x = 20$ $x = 10$ Then the present age of B is $3 \times x = 3 \times 10 = 30$ years. After 5 years the age of B is $30 + 5 = 35$ years.

**Question 24 :**

In the question given below four sentences are given which may or may not be grammatically correct. Find the sentences which are both grammatically and contextually correct and choose the option according to it. If all the sentences are grammatically and contextually correct then choose option 5 i.e. "All are correct" as your choice. I. Fourteen kilometers are not a short distance, to reach my office daily. II. Good reading reflect the sense of liberal educated mind III. Mohanlal's train was late and it reached Kolkata a little after midnight. IV. If you transform your energy positively, it naturally becomes compassion and love.

Difficulty : Moderate

Average Time : 81 Seconds

**Options :**

1. Only I
2. Only II
3. Both II and III
4. Both III and IV
5. All are correct

**Solution :**

The correct answer is option 4 i.e. Both III and IV.

Concept/Grammar Rules	Application
The given question suggests finding the statements that are grammatically or contextually incorrect.	<p>In the first sentence “are” should not be used instead “is” should be used. The subject here is “fourteen kilometers” which is distance and is singular.</p> <p>In the second sentence “reflect” should be replaced with “reflects”. Verb with a third-person singular noun or pronoun as a subject has an additional “s” at the end.</p> <p>Hence the chosen option is correct.</p>

**Question 25 :**

In the question given below four sentences are given which may or may not be grammatically correct. Find the sentences which are both grammatically and contextually correct and choose the option according to it. If all the sentences are grammatically and contextually correct then choose option 5 i.e. “All are correct” as your choice. I Ability and technology averse the relationship between motivation and performance. II Job performance is affected by a number of factors. III He adverted to the problem of air pollution in his speech. IV Swami Dayanand Saraswati is remembered for reverence and affection among the social reformers of the nineteenth century.

**Difficulty : Moderate****Average Time : 101 Seconds****Options :**

1. Only I
2. Only III

Both III and IV

4. Both I and III

5. All are correct.

**Solution :**

The correct answer is option 2 i.e. Only III.

Concept/Grammar Rules	Application
The given question suggests finding the statements that are grammatically or contextually incorrect.	<p>In the first sentence the word “averse” should be replaced with “moderates” to make the sentence meaningful.</p> <p>In the second sentence “effected” should be replaced with “affected” to make the sentence meaningful.</p> <p>In the fourth sentence “for” should be replaced with “with” to make the sentence grammatically correct as “reverence” means to respect and we use “with” to refer to what we use to do something.</p> <p>Hence the chosen option is correct.</p>

**Question 26 :**

In the question given below four sentences are given which may or may not be grammatically correct. Find the sentences

which are both grammatically and contextually correct and choose the option according to it. If all the sentences are grammatically and contextually correct then choose option 5, "All are correct" as your choice. I. India is a country that respects spiritualism much more than materialism. II. When we talk about investing in education, a question arises as to what kind of education needs to be given to the youngsters. III. Rohan is so magnanimous that everyone is always eager to help him in his project. IV. She is the best and the wisest girl in the class.

**Difficulty : Moderate****Average Time : 108 Seconds****Options :**

1. Only I
2. Only III
3. Both III and IV
4. Both I and III
5. All are correct

**Solution :****The correct answer is option 5 i.e., All are correct.**

Concept/Grammar Rules	Application
The given question suggests finding the statements that are grammatically or contextually incorrect.	All of the sentences are contextually as well as grammatically correct.

**Question 27 :**

In the question given below four sentences are given which may or may not be grammatically correct. Find the sentences which are both grammatically and contextually correct and choose the option according to it. If all the sentences are grammatically and contextually correct then choose option 5, "all are correct" as your choice. I. The chairman appointed her as a secretary as she is efficient. II. The most important source of energy today are coal and natural gas, hydroelectricity, and nuclear power. III. My sister's marriage passed by peacefully. IV. There are few books on computer science in your school library, so you need to purchase them from the market.

**Difficulty : Moderate****Average Time : 85 Seconds****Options :**



- Only I
- 2. Only III
- 3. Both II and IV
- 4. Both I and IV
- 5. All are correct

**Solution :**

The correct answer is option 4 i.e. Both I and IV.

Concept/Grammar Rules	Application
The given question suggests finding the statements that are grammatically or contextually incorrect.	<p>In the second sentence, the word “are” should be replaced with “is” as there are many sources and the most important is being listed.</p> <p>In the third sentence the preposition “by” should be replaced with “off” to make the sentence grammatically correct.</p> <p>Hence, the chosen option is correct.</p>

**Comprehension :**

Directions: What will come in place of question mark (?) in the following question?

**Question 28 :**

$$(0.000729)^{1/6} \text{ of } (90)^{2/9} + (12)^2 = ?$$

Difficulty : Moderate

Average Time : 67 Seconds

**Options :**

1. 414
2. 225
3. 729
4. 1000
5. 1240

**Solution :**

The correct answer is **Option 1** i.e. **414**.

$$(0.000729)^{1/6} \text{ of } (90)^2/9 + (12)^2 = ?$$

$$(729/10^6)^{1/6} \text{ of } 8100/9 + 144 = ?$$

$$3/10 \times 8100/9 + 144 = ?$$

$$2430/9 + 144 = ?$$

$$270 + 144 = ?$$

$$414 = ?$$

**Comprehension :**

Directions: What will come in place of the question mark(?) in the following number series?

**Question 29 :**

12, 4096, 36, 1024, ?, 256, 324

Difficulty : Moderate

Average Time : 43 Seconds

**Options :**

1. 108
2. 110
3. 104
4. 150
5. 170

**Solution :**

The correct answer is **Option 1** i.e. **108**.



12, 4096, 36, 1024, ?, 256, 324

The given series is a mixture of two series

Series 1 :

$$12 \times 3 = 36$$

$$36 \times 3 = 108$$

$$108 \times 3 = 324$$

Series 2 :

$$4096/4 = 1024$$

$$1024/4 = 256$$

So, the missing term would be 108

**Comprehension :**

Directions: What will come in place of the question mark(?) in the following number series?

**Question 30 :**

5, 3125, 25, 625, ?, 125

**Difficulty : Moderate**

**Average Time : 45 Seconds**

**Options :**

1. 25
2. 325
3. 125
4. 152
5. 110

**Solution :**

The correct answer is **Option 3** i.e. **125**.

5, 3125, 25, 625, ?, 125

The given sequence is a mixture of two series:

Series 1 -



$$5 \times 5 = 25$$

$$25 \times 5 = 125$$

Series 2 -

$$3125/5 = 625$$

$$625/5 = 125$$

### Comprehension :

Directions: What will come in place of the question mark(?) in the following number series?

#### Question 31 :

50, 60, 46, 64, ?, 68, 38

Difficulty : Moderate

Average Time : 43 Seconds

#### Options :

1. 20
2. 24
3. 50
4. 54
5. 42

#### Solution :

The correct answer is **Option 5** i.e. **42**.

50, 60, 46, 64, ?, 68, 38

The given series is a mixture of two series

Series 1 -

$$50 - 4 = 46$$

$$46 - 4 = 42$$

$$42 - 4 = 38$$

Series 2 -

$$60 + 4 = 64$$



$$64 + 4 = 68$$

**Comprehension :**

Directions: What will come in place of the question mark(?) in the following number series?

**Question 32 :**

11,  $13/2$ ,  $21/4$ , ?,  $109/16$

Difficulty : Difficult

Average Time : 45 Seconds

**Options :**

1.  $53/6$
2.  $45/8$
3.  $51/2$
4.  $83/4$
5.  $57/8$

**Solution :**

The correct answer is **Option 2** i.e.  $45/8$ .

11,  $13/2$ ,  $21/4$ , ?,  $109/16$

$$11 \times 1/2 + 1 = 13/2$$

$$13/2 \times 1/2 + 2 = 21/4$$

$$21/4 \times 1/2 + 3 = 45/8$$

$$45/8 \times 1/2 + 4 = 109/16$$

**Comprehension :**

Directions: What will come in place of question mark (?) in the following question?

**Question 33 :**

$50/3$  of  $243 + 54/4 \times 324 - 12/5 \times 405 = ? \times 81$

Difficulty : Moderate

Average Time : 40 Seconds

**Options :**

1. 52
2. 36



42

4. 92

5. 94

**Solution :**

The correct answer is **Option 4** i.e. **92**.

Using the rule of BODMAS :

$$50/3 \text{ of } 243 + 54/4 \times 324 - 12/5 \times 405 = ? \times 81$$

$$50 \times 81 + 54 \times 81 - 12 \times 81 = ? \times 81$$

$$50 + 54 - 12 = ?$$

$$? = 92$$

**Comprehension :**

Directions: What will come in place of question mark (?) in the following question?

**Question 34 :**

$$[1050 + 25 \times 5 - 7 \times 3 + 32] \div 2 = ?$$

**Difficulty : Moderate****Average Time : 44 Seconds****Options :**

1. 592

2. 596

3. 593

4. 521

5. 546

**Solution :**

The correct answer is **Option 3** i.e. **593**.

Using the rule of BODMAS,

$$[1050 + 25 \times 5 - 7 \times 3 + 32] \div 2 = ?$$

$$[(1050 + 125 - 21 + 32)] \div 2 = ?$$



$$[1207 - 21] \div 2 = ?$$

$$? = 593$$

**Comprehension :**

Directions: What will come in place of question mark (?) in the following question?

**Question 35 :**

$$(255/8)/(5/320) - (125/7)/(5/21) + 25/5 = ?$$

**Difficulty : Moderate****Average Time : 41 Seconds****Options :**

1. 1950
2. 1980
3. 1254
4. 1970
5. 1234

**Solution :**

The correct answer is **Option 4** i.e. **1970**.

Using the rule of BODMAS :

$$(255/8)/(5/320) - (125/7)/(5/21) + 25/5 = ?$$

$$51 \times 40 - (125 \times 21)/(5 \times 7) + 5 = ?$$

$$2040 - 75 + 5 = ?$$

$$? = 1970$$

**Comprehension :**

Directions: What will come in place of the question mark(?) in the following number series?

**Question 36 :**

45, 50, 59, 71, ?

**Difficulty : Moderate****Average Time : 40 Seconds****Options :**

1. 83

86

3. 85

4. 84

5. 87

**Solution :**The correct answer is **Option 3** i.e. **85**.

45, 50, 59, 71, ?

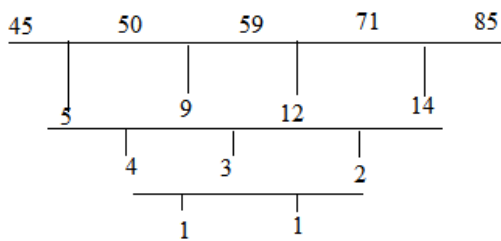

The given number series follows the given pattern, hence the missing term is 85.

**Question 37 :**

The two taps A and B can fill the tank alone in 5 hours and 10 hours respectively. However, there is a hole in the tank at 25% above the height of the tank from the bottom. If that hole had been at bottom, it could empty the tank in 4 hours. How much time it would take to fill the tank completely?

**Difficulty : Moderate****Average Time : 55 Seconds****Options :**

1. 8 hours
2. 8.5 hours
3. 7.5 hours
4. 7 hours
5. 9 hours

**Solution :**The correct answer is **option 3** i.e. **7.5 hours**

Given,





A can fill the tank in 5 hours i.e  $100/5 = 20\%$  per hour

B can fill the tank in 10 hours i.e.  $100/10 = 10\%$  per hours

Together, they can fill  $20\% + 10\% = 30\%$  tank per hour

For first 75%, hole will not be into action, so 75% of tank will be filled in:  $75/30 = 2.5$  hours

For last 25%, hole will be in action

Given, hole can empty the tank in 4 hours i.e.  $100/4 = 25\%$  per hour

Hence, together A,B and Hole will fill  $(20 + 10 - 25 = 5\%)$  per hour

So, to fill last 25% of tank,  $25/5 = 5$  hour is needed.

Total time =  $2.5 + 5 = 7.5$  hours

### Comprehension :

Direction: The table below shows the number of people who go to different foreign countries (USA, Australia, Singapore, UK, and Sweden) for different purposes (Tourism and Business). The male and female ratio is also given. Some of the values are missing. Study the data carefully and answer the questions that follow. 

	Tourism	Business	Total people	Male : female
USA	640	5	3 500	-
Australia	-	3	4 355	2 : 3
Singapore	520	8	5 - 1	2
UK	405	-	540	7
Sweden	480	2	1 - 11	10

### Question 38 :

If a total of 382 males have gone to Australia then, find the total number of people who have gone to Australia for Tourism only.

Difficulty : Moderate

Average Time : 84 Seconds

### Options :

1. 420
2. 580
3. 560
4. 630
5. 490

### Solution :

The correct answer is **option 3** i.e. **560**.

From the table:



Number of males who have gone to Australia for business =  $355 \times \frac{2}{5} = 142$

Since a total of 382 males have gone to Australia

So,

Number of males who have gone to Australia for tourism =  $382 - 142 = 240$

Hence,

Total number of people who have gone to Australia for Tourism only

$$240 \times \frac{7}{3} = 560$$

**Comprehension :**

Direction: The table below shows the number of people who go to different foreign countries (USA, Australia, Singapore, UK, and Sweden) for different purposes (Tourism and Business). The male and female ratio is also given. Some of the values are missing. Study the data carefully and answer the questions that follow.

	Tourism	Business	Total people	Male : female
USA	640	500	1140	5 : 3
Australia	350	355	705	2 : 3
Singapore	520	80	600	5 : 1
UK	405	140	545	7 : 2
Sweden	480	525	1005	11 : 10

**Question 39 :**

The total number of people who have gone to Sweden is 1005 then, find the number of males who have gone to Sweden for business.

Difficulty : Moderate

Average Time : 72 Seconds

**Options :**

1. 275
2. 250
3. 225
4. 325
5. 300

**Solution :**

The correct answer is **option 1** i.e. **275**.

The total number of people who have gone to Sweden is 1005

From the table:

Number of people who have gone to Sweden for Tourism = 480



So,  
Number of people who have gone to Sweden for business

$$1005 - 480 = 525$$

So,  
Number of males who have gone to Sweden for business

$$525 \times \frac{11}{21} = 275$$

**Comprehension :**

Direction: The table below shows the number of people who go to different foreign countries (USA, Australia, Singapore, UK, and Sweden) for different purposes (Tourism and Business). The male and female ratio is also given. Some of the values are missing. Study the data carefully and answer the questions that follow.

	Tourism	Business	Total people	Male : female
USA	640	5	3	500
Australia	3	4	355	2 : 3
Singapore	520	8	5	1 : 2
UK	405	540	7	2
Sweden	480	2	1	11 : 10

**Question 40 :**

The total number of females who have gone to Singapore and the UK for tourism is 425. What is the ratio of males and females who have gone to the UK for tourism?

**Difficulty : Moderate****Average Time : 74 Seconds****Options :**

1. 3 : 5
2. 4 : 5
3. 3 : 4
4. 2 : 3
5. 4 : 3

**Solution :**

The correct answer is **option 2** i.e. **4 : 5**.

From the table:

Number of females who have gone to Singapore for tourism =  $520 \times \frac{5}{13} = 200$

The total number of females who have gone to Singapore and the UK for tourism is 425

So,



Number of females who have gone to the UK for tourism

$$425 - 200 = 225$$

Since the total number of people who have gone to the UK for tourism is 405

Number of males who have gone to UK for tourism

$$405 - 225 = 180$$

Hence,

$$\text{Required ratio} = 180 : 225 = 4 : 5$$

**Comprehension :**

Direction: The table below shows the number of people who go to different foreign countries (USA, Australia, Singapore, UK, and Sweden) for different purposes (Tourism and Business). The male and female ratio is also given. Some of the values are missing. Study the data carefully and answer the questions that follow.

	Tourism	Business	Total people	Male : female
USA	640	500	1140	5 : 3
Australia	355	320	675	3 : 2
Singapore	520	80	600	8 : 5
UK	405	540	945	7 : 2
Sweden	480	110	590	2 : 1

**Question 41 :**

Find the total number of people who have gone to Singapore if 280 females have gone to Singapore for Business.

Difficulty : Moderate

Average Time : 78 Seconds

**Options :**

1. 920
2. 880
3. 960
4. 860
5. 940

**Solution :**

The correct answer is **option 5** i.e. **940**.

Given: 280 females have gone to Singapore for Business.

From the table:

$$\text{Total number of people who have gone to Singapore for Business} = 280 \times \frac{3}{2} = 420$$

Hence,



Total number of people who have gone to Singapore =  $520 + 420 = 940$

**Comprehension :**

Direction: The table below shows the number of people who go to different foreign countries (USA, Australia, Singapore, UK, and Sweden) for different purposes (Tourism and Business). The male and female ratio is also given. Some of the values are missing. Study the data carefully and answer the questions that follow.

	Tourism	Business	Total people	Male : female
USA	640	5	3	500
Australia	3	4	355	2 : 3
Singapore	520	8	5	1 : 2
UK	405	540	7	2
Sweden	480	2	1	11 : 10

**Question 42 :**

Find the ratio of males and females who have gone to the USA for Business if a total of 750 males have gone to the USA.

Difficulty : Moderate

Average Time : 66 Seconds

**Options :**

1. 8 : 3
2. 5 : 3
3. 3 : 2
4. 7 : 3
5. 2 : 3

**Solution :**

The correct answer is **option 4** i.e. **7 : 3**.

Given: A total of 750 males have gone to the USA

From the table:

Number of males who have gone to the USA for tourism

$$640 \times \frac{5}{8} = 400$$

So,

Number of males who have gone to the USA for business

$$750 - 400 = 350$$

Since the total number of people who have gone to the USA for business is 500

Number of females who have gone to USA for business

$$500 - 350 = 150$$



Hence,

Required ratio =  $350 : 150 = 7 : 3$

**Comprehension :**

Directions: What will come in place of question mark (?) in the following question?

**Question 43 :**

$(0.343)^{1/3} \times 700 = (?)^2 + 6 \times 15$

Difficulty : Moderate

Average Time : 58 Seconds

**Options :**

1. 20
2. 15
3. 10
4. 22
5. 25

**Solution :**

The correct answer is **Option 1** i.e. **20**.

$$(0.343)^{1/3} \times 700 = (?)^2 + 6 \times 15$$

$$(7/10) \times 700 = (?)^2 + 90$$

$$(?)^2 = 490 - 90$$

$$? = (400)^{1/2}$$

$$? = 20$$

**Question 44 :**

In the following sentence, a part of the sentence is emboldened. Below are given alternatives to the emboldened part, which may improve or replace the meaning of the sentence. Choose the correct alternative. In case no improvement is needed, choose the alternative that indicates 'No improvement required.' They must charge the lead in civilising our streets and reclaiming them for local communities.

Difficulty : Moderate

Average Time : 54 Seconds

**Options :**

Charge for the lead

- 2. Lead
- 3. Take lead
- 4. Take the lead
- 5. No improvement required

**Solution :**

The correct answer is **Option 4** i.e. **Take the lead.**

Concept/Grammar Rules	Application
The question seeks for an appropriate representation of the given sentence so as to make it seem both grammatically as well as contextually appropriate.	<p>The emboldened phrase "Charge the lead" should be "Take the lead" which seems to be the correct expression.</p> <p>The correct form of "<b>Take the lead</b>" means "<i>to go forward.</i>"</p> <p>The correct sentence is: <b>They must take the lead in civilising our streets and reclaiming them for local communities.</b></p> <p>Hence, the correct answer is <b>Option 4</b> i.e. <b>Take the lead.</b></p>

**Question 45 :**

In the following questions, a statement is divided into 5 different segments. Part (A) in the sentence is fixed and other parts

may not be in the correct sequence. You have to rearrange the other parts of the sentence to make it contextually and grammatically correct and if the correct option of sequence doesn't match any of the given sequence mark (5) i.e., "None of the above" as your answer. The government's push to reform India's agriculture sector has (A)/ of Indian agriculture are noteworthy (B)/ debate, two long-standing characteristics (C)/ divided opinions and triggered a debate (D)/ about the state of Indian agriculture. In the context of this (E).

**Difficulty : Moderate**

**Average Time : 103 Seconds**

**Options :**

1. ADCBE
2. ADECB
3. ACBDE
4. ABCDE
5. None of the above

**Solution :**

The correct answer is **option 2 i.e. ADECB.**

Concept/Grammar Rules	Application
-----------------------	-------------



The query is to rearrange the given jumbled parts to form a meaningful sentence.	The correct sequence is ADECB:  "The government's push to reform India's agriculture sector has divided opinions and triggered a debate about the state of Indian agriculture. In the context of this debate, two long-standing characteristics of Indian agriculture are noteworthy."  Hence, option 2 is correct
--	--

**Question 46 :**

In the following questions, a statement is divided into 5 different segments. Part (A) in the sentence is fixed and other parts may not be in the correct sequence. You have to rearrange the other parts of the sentence to make it contextually and grammatically correct and if the correct sequence doesn't match any of the given sequences, mark (5) i.e., "None of the above" as your answer. In the Sheikh Jarrah neighbourhood of East Jerusalem, (A)/ of several Palestinian families (B)/ the impending eviction (C)/ the Israeli courts have recently declared (D)/ from their homes to be legal. (E)

**Difficulty : Moderate****Average Time : 84 Seconds****Options :**

1. ADBEC
2. ADECB
3. ADCBE
4. ABCDE
5. None of the above

**Solution :**

The correct answer is **option 3 i.e. ADCBE**

Concept/Grammar Rules	Application
The query is to rearrange the given jumbled parts to form a meaningful sentence.	The correct sequence of the sentence ADCBE:  'In the Sheikh Jarrah neighbourhood of East Jerusalem, the Israeli courts have recently declared the impending eviction of several Palestinian families from their homes to be legal.'  Hence, <b>option 3</b> is correct.

**Comprehension :**

Directions: What will come in place of question mark (?) in the following question?

**Question 47 :**

$$(25)^{7.5} \times (5)^{2.5} \div (125)^{1.5} = 5^?$$

**Difficulty : Moderate****Average Time : 60 Seconds****Options :**

1. 7
2. 13
3. 15
4. 17
5. None of these

**Solution :**

The correct answer is **Option 2** i.e. **13**.

$$(25)^{7.5} \times (5)^{2.5} \div (125)^{1.5} = 5^?$$

$$(5)^{2 \times 7.5} \times (5)^{2.5} \div (5)^{3 \times 1.5} = 5^?$$

$$(5)^{15} \times (5)^{2.5} \div (5)^{4.5} = 5^?$$

$$(5)^{15 + 2.5 - 4.5} = (5)^?$$

$$? = 15 + 2.5 - 4.5$$

$$? = 13$$

**Question 48 :**

In the following questions, a statement is divided into 5 different segments. Part (A) in the sentence is fixed and other parts may not be in the correct sequence. You have to rearrange the other parts of the sentence to make it contextually and grammatically correct and if the correct option of sequence doesn't match any of the given sequence mark (5) i.e., "None of the above" as your answer. The Stockholm Convention on Persistent Organic Pollutants is a global (A)/ that remain intact in the environment for long periods, become widely distributed geographically, (B)/ treaty to protect human health and the environment from chemicals (C)/ impacts on human health or on the environment (D)/ accumulate in the fatty tissue of humans and wildlife, and have harmful (E).

Difficulty : Moderate

Average Time : 80 Seconds

**Options :**

1. ACBED
2. ACBDE
3. ADBCE
4. ABCDE
5. None of the above

**Solution :**

The correct answer is **option 1 i.e. ACBED.**

Concept/Grammar Rules	Application
-----------------------	-------------

The query is to rearrange the given jumbled parts to form a meaningful sentence.

The correct sequence is ACBED:

"The Stockholm Convention on Persistent Organic Pollutants is a global treaty to protect human health and the environment from chemicals that remain intact in the environment for long periods, become widely distributed geographically, accumulate in the fatty tissue of humans and wildlife, and have harmful impacts on human health or on the environment."

Hence, option 1 is correct.

**Question 49 :**

A sentence with an emboldened part is given below. This sentence is followed by three different phrases that could be a suitable alternative(s) for the emboldened part. Choose the phrase(s) (one or more than one) that could replace the one given in the sentence. If the sentence is correct as it is and does not require any improvement as such then mark (E) i.e., "No Improvement required" as your answer. Rashmi hates everybody and everything which remind her of her mistakes i) which have reminded ii) who reminds her iii) that reminds her

**Difficulty : Moderate****Average Time : 88 Seconds****Options :**

1. Only i
2. Only ii

Only iii

4. ii and iii

5. No improvement required

**Solution :**

The correct answer is option 3 i.e. Only iii.

Concept/Grammar rules	Applications
The theme of the question is to find the best alternative for the highlighted word so as to make the sentence both grammatically as well as contextually appropriate.	The answer is 'that reminds her'. When two antecedents are connected by 'and' if one of them is a person and the other an object then we use 'that' as a relative pronoun.  Hence, option 3 is the correct answer.

**Question 50 :**

Which of the words/phrases (A), (B), (C) given below should replace the words/phrases respectively in the following sentences to make them meaningful and grammatically correct. If the sentence is correct, then mark the option "No Improvement Required". While (A) stressing the role of investment in (B) restored the economy the Economic Survey also states that the twin balance sheet issue has to be (C) undertake on an urgent basis.

Difficulty : Moderate

Average Time : 82 Seconds

**Options :**

1. Highlighting, slowing, tackled
2. emphasizing, stimulating, addressed
3. shouting, excited, focused
4. Assuaging, invigorating, overlooked

No improvement required

**Solution :**

The correct answer is **Option 2** i.e. **emphasizing, stimulating, addressed.**

Concept/Grammar rules	Applications
-----------------------	--------------





The theme of the question is to find the best alternative for the three fragments of the sentence so as to make the sentence both grammatically as well as contextually appropriate.

The original statement is incorrect due to as restored does not make sense. The investment would help in restoring an economy and not with an already restored economy. Also, the tense of undertake is incorrect.

**Option A:** Slowing is opposite to the correct meaning and is incorrect.

**Option C:**

Shouting does not make sense as the first word. The other two words also do not make sense in the statement due to being incorrect in terms of meaning.

**Option D:** assuaged means relieved and does not fit in contextually. Also, overlooked is opposite of the correct meaning.

**Option B:** All the words fit in well.

The statement after replacement:

**While emphasizing the role of investment in stimulating the economy the Economic Survey also states that the twin balance sheet issue has to be addressed on**

**Question 51 :**

Each question consists of four sentences and some sentences are grammatically incorrect or inappropriate. Read each sentence to find out the error in the sentence(s) and select the option that indicates the grammatically incorrect and inappropriate sentence (s). Ignore the errors of punctuation, if any. A. As much with ease with the pen, Ram Prasad Bismil was equally adept at wielding the pistol too. B. This fire-spitting revolutionary believed in attaining freedom by force. C. Bismil's life and writing along with that of others is essential to make today's generation aware in the country's freedom struggle. D. It will help tackle today's prevailing corruption and communalism.

Difficulty : Moderate

Average Time : 130 Seconds

**Options :**

1. Only B
2. A and C
3. B and D
4.  A, C and D
5. All are incorrect

**Solution :**

The correct answer is **Option 2** i.e. **A and C**.

**The explanation for each wrong sentence:**

- A. *As much with ease with the pen, Ram Prasad Bismil was equally adept at wielding the pistol too.*
- We need to replace the preposition 'with' with '**at**' here.
- C. *Bismil's life and writing along with that of others is essential to make today's generation aware in the country's freedom struggle.*
- We can make people aware '**of**' things.

Hence, the correct answer is **Option 2** i.e. **A and C**.

**Comprehension :**

Read the passage carefully and answer the questions that follow. The passage of a statutory resolution and a Bill in Parliament — “abrogating” Article 370 which confers special political status on Jammu and Kashmir, and bifurcating the State into two Union Territories — has robbed the Kashmir Valley of its political autonomy, or whatever remains of it after all these years. It may deepen the State's trust deficit vis-a-vis the Centre. The “abrogation” of Article 370, being hailed as a “glorious” move, is itself a misnomer. “Amending” or “abrogating” Article 370 is a Constitutional improbability; the amending provision of Article 368 says no Constitutional amendments have effect in relation to J&K unless applied by Order of the President under Article 370 that requires the concurrence of the State's legislature and ratification by its





Constituent Assembly. The moves on Monday can be seen as an exercise in political optics, pandering to a certain majoritarian sentiment. What the Centre has done is to shred even the garb of democracy and spirit of dialogue that successive governments felt was important to engage the people of Kashmir. Through as many as 45 Presidential Orders, the most critical being the Order of 1954, Article 370 has already been divested of its spirit. Secessionist elements and some Indian Constitutional experts have cited this gradual advance of the Union as the conquest of the Valley by stealth. What even this controversial process of assimilation, with Article 370 in place, has done is to achieve the growth of local political engagement. It legitimises a pan-Indian sentiment in the Valley where the secessionists would like to portray India as a mere occupational force. Indeed, there are several other provisions in the Constitution such as Article 371(A), 371(G), 371(B), 371(C) that validate indigenous political forces in States like Nagaland, Mizoram, Assam, Manipur et al. This asymmetric form of federalism has its global parallels in the substantial autonomy enjoyed by Scotland and Wales and Northern Ireland within Great Britain. The protests in Hong Kong affirm the relevance of democratic processes inherent in the one country-two systems followed even by China. By robbing Article 370 of its special provisions, the BJP has undermined these nuanced and extremely critical democratic processes. Simultaneously, the State has been carved up into two Union Territories with J&K having a legislature and Ladakh without it. The unprecedented step of reorganizing a State and divesting it of its legislative authority without even a semblance of consultation with the stakeholders sets a dangerous precedent underlined by several regional groups and political parties, particularly the DMK and the MDMK. It is possible that the BJP would reap rich political dividends for this muscular policy. But the Centre would be responsible for the escalation of violence in the Valley where all doors for political engagement and democratic exchange seem to have been closed down for good. Without meaningful participation of the people, any such unilateral integration can remain at best territorial.

**Question 52 :**

Which among the following is correct regarding the Article 368 in the Constitution of India, as stated in the passage?

**Difficulty : Moderate****Average Time : 201 Seconds****Options :**

1. It should not go unattended if there is something within the purview of the state and the centre.
2. It should be noted that there are so many issues in the offing so that the central government can come.
3. Any law can be implemented in Jammu and Kashmir only if there is support from the state legislature.
4. The state of Jammu and Kashmir should note that India will not remain spectators in the whole thing.
5. None of the above

**Solution :**

The correct answer is **Option 3** i.e. **Any law can be implemented in Jammu and Kashmir only if there is support from the state legislature.**

Read the following paragraph of the given passage:

- *“Amending” or “abrogating” Article 370 is a Constitutional improbability; the amending provision of Article 368 says no Constitutional amendments have effect in relation to J&K unless applied by Order of the President under Article 370 that requires the concurrence of the State’s legislature and ratification by its Constituent Assembly.’*

Clearly, **“any law can be implemented in Jammu and Kashmir only if there is support from the state legislature”** is the most appropriate choice among the given options.

### Comprehension :

Read the passage carefully and answer the questions that follow. The passage of a statutory resolution and a Bill in Parliament — “abrogating” Article 370 which confers special political status on Jammu and Kashmir, and bifurcating the State into two Union Territories — has robbed the Kashmir Valley of its political autonomy, or whatever remains of it after all these years. It may deepen the State’s trust deficit vis-a-vis the Centre. The “abrogation” of Article 370, being hailed as a “glorious” move, is itself a misnomer. “Amending” or “abrogating” Article 370 is a Constitutional improbability; the amending provision of Article 368 says no Constitutional amendments have effect in relation to J&K unless applied by Order of the President under Article 370 that requires the concurrence of the State’s legislature and ratification by its Constituent Assembly. The moves on Monday can be seen as an exercise in political optics, pandering to a certain majoritarian sentiment. What the Centre has done is to shred even the garb of democracy and spirit of dialogue that successive governments felt was important to engage the people of Kashmir. Through as many as 45 Presidential Orders, the most critical being the Order of 1954, Article 370 has already been divested of its spirit. Secessionist elements and some Indian Constitutional experts have cited this gradual advance of the Union as the conquest of the Valley by stealth. What even this controversial process of assimilation, with Article 370 in place, has done is to achieve the growth of local political engagement. It legitimises a pan-Indian sentiment in the Valley where the secessionists would like to portray India as a mere occupational force. Indeed, there are several other provisions in the Constitution such as Article 371(A), 371(G), 371(B), 371(C) that validate indigenous political forces in States like Nagaland, Mizoram, Assam, Manipur et al. This asymmetric form of federalism has its global parallels in the substantial autonomy enjoyed by Scotland and Wales and Northern Ireland within Great Britain. The protests in Hong Kong affirm the relevance of democratic processes inherent in the one country-two systems followed even by China. By robbing Article 370 of its special provisions, the BJP has undermined these nuanced and extremely critical democratic processes. Simultaneously, the State has been carved up into two Union Territories with J&K having a legislature and Ladakh without it. The unprecedented step of reorganizing a State and divesting it of its legislative authority without even a semblance of consultation with the stakeholders sets a dangerous precedent underlined by several regional groups and political parties, particularly the DMK and the MDMK. It is possible that the BJP would reap rich political dividends for this muscular policy. But the Centre would be responsible for the escalation of violence in the Valley where all doors for political engagement and democratic exchange seem to have been closed down for good. Without meaningful participation of the people, any such unilateral integration can remain at best territorial.

### Question 53 :

Which among the following is correct about Scotland and Wales as stated in the passage?

Difficulty : Moderate

Average Time : 219 Seconds

Options :

1. The area comes under the supervision of India whereas the rest of the country does not come here.
2. The area is within suspension by the international territory though other areas are also accepting it.
3. The area enjoys a similar status just like Jammu and Kashmir in India and there are several other areas like this.
4. This area has been in the storm of the dispute between various countries because there are so many problems.
5. None of the above

Solution :

The correct answer is **Option 3** i.e. **The area enjoys a similar status just like Jammu and Kashmir in India and there are several other areas also like this.**

- Refer to the sentence in the passage that cites: *“This asymmetric form of federalism has its global parallels in the substantial autonomy enjoyed by Scotland and Wales and Northern Ireland within Great Britain.”*
- It says that the area of Scotland and Wales are within the jurisdiction of Great Britain and the areas are governed by the autonomous bodies.
- This is actually similar to the status of Jammu and Kashmir in India because till now Jammu and Kashmir also enjoyed similar autonomy in India.
- Among the given options, we can choose option 3 since it provides us with the correct information regarding the similarity between Jammu and Kashmir and Scotland and Wales.

Comprehension :

Read the passage carefully and answer the questions that follow. The passage of a statutory resolution and a Bill in Parliament — “abrogating” Article 370 which confers special political status on Jammu and Kashmir, and bifurcating the State into two Union Territories — has robbed the Kashmir Valley of its political autonomy, or whatever remains of it after all these years. It may deepen the State’s trust deficit vis-a-vis the Centre. The “abrogation” of Article 370, being hailed as a “glorious” move, is itself a misnomer. “Amending” or “abrogating” Article 370 is a Constitutional improbability; the amending provision of Article 368 says no Constitutional amendments have effect in relation to J&K unless applied by Order of the President under Article 370 that requires the concurrence of the State’s legislature and ratification by its Constituent Assembly. The moves on Monday can be seen as an exercise in political optics, pandering to a certain majoritarian sentiment. What the Centre has done is to shred even the garb of democracy and spirit of dialogue that successive governments felt was important to engage the people of Kashmir. Through as many as 45 Presidential Orders, the most critical being the Order of 1954, Article 370 has already been divested of its spirit. Secessionist elements and



some Indian Constitutional experts have cited this gradual advance of the Union as the conquest of the Valley by stealth. What even this controversial process of assimilation, with Article 370 in place, has done is to achieve the growth of local political engagement. It legitimises a pan-Indian sentiment in the Valley where the secessionists would like to portray India as a mere occupational force. Indeed, there are several other provisions in the Constitution such as Article 371(A), 371(G), 371(B), 371(C) that validate indigenous political forces in States like Nagaland, Mizoram, Assam, Manipur et al. This asymmetric form of federalism has its global parallels in the substantial autonomy enjoyed by Scotland and Wales and Northern Ireland within Great Britain. The protests in Hong Kong affirm the relevance of democratic processes inherent in the one country-two systems followed even by China. By robbing Article 370 of its special provisions, the BJP has undermined these nuanced and extremely critical democratic processes. Simultaneously, the State has been carved up into two Union Territories with J&K having a legislature and Ladakh without it. The unprecedented step of reorganizing a State and divesting it of its legislative authority without even a semblance of consultation with the stakeholders sets a dangerous precedent underlined by several regional groups and political parties, particularly the DMK and the MDMK. It is possible that the BJP would reap rich political dividends for this muscular policy. But the Centre would be responsible for the escalation of violence in the Valley where all doors for political engagement and democratic exchange seem to have been closed down for good. Without meaningful participation of the people, any such unilateral integration can remain at best territorial.

**Question 54 :**

Which among the following is correct regarding the possible consequence of the decision taken by the centre to abrogate Section 370?

**Difficulty : Moderate****Average Time : 226 Seconds****Options :**

1. The people of the area will not understand the importance of autonomy and they will come to India.
2. The people of the area will have more trust deficit with the mainland government of India since they will feel things are not being in their interests.
3. The people in the area will not be within the jurisdiction of the police and the army of the central government.
4. It will have no impact on the population of Jammu and Kashmir though they are yet to know the fact.
5. None of the above

**Solution :**

The correct answer is **Option 2** i.e. **The people of the area will have more trust deficit with the mainland government of India since they will feel things are not being in their interests.**

It is clear from the passage that:



The decision by the government to revoke Section 370 without discussing anything with the local political parties will have a far-reaching impact on the relationship between India and Jammu & Kashmir.

- Therefore the people in the area will not feel that the Indian government is working to fulfill their interests but they are only working in the interests of the mainland country.
- It will definitely increase the trust deficit between the people in India and the state of Jammu and Kashmir.
- Among the given options, we can easily choose Option 2 since it provides us with the correct information whereas the rest can be eliminated from consideration since they do not follow from the passage.

**Comprehension :**

Read the passage carefully and answer the questions that follow. The passage of a statutory resolution and a Bill in Parliament — “abrogating” Article 370 which confers special political status on Jammu and Kashmir, and bifurcating the State into two Union Territories — has robbed the Kashmir Valley of its political autonomy, or whatever remains of it after all these years. It may deepen the State’s trust deficit vis-a-vis the Centre. The “abrogation” of Article 370, being hailed as a “glorious” move, is itself a misnomer. “Amending” or “abrogating” Article 370 is a Constitutional improbability; the amending provision of Article 368 says no Constitutional amendments have effect in relation to J&K unless applied by Order of the President under Article 370 that requires the concurrence of the State’s legislature and ratification by its Constituent Assembly. The moves on Monday can be seen as an exercise in political optics, pandering to a certain majoritarian sentiment. What the Centre has done is to shred even the garb of democracy and spirit of dialogue that successive governments felt was important to engage the people of Kashmir. Through as many as 45 Presidential Orders, the most critical being the Order of 1954, Article 370 has already been divested of its spirit. Secessionist elements and some Indian Constitutional experts have cited this gradual advance of the Union as the conquest of the Valley by stealth. What even this controversial process of assimilation, with Article 370 in place, has done is to achieve the growth of local political engagement. It legitimises a pan-Indian sentiment in the Valley where the secessionists would like to portray India as a mere occupational force. Indeed, there are several other provisions in the Constitution such as Article 371(A), 371(G), 371(B), 371(C) that validate indigenous political forces in States like Nagaland, Mizoram, Assam, Manipur et al. This asymmetric form of federalism has its global parallels in the substantial autonomy enjoyed by Scotland and Wales and Northern Ireland within Great Britain. The protests in Hong Kong affirm the relevance of democratic processes inherent in the one country-two systems followed even by China. By robbing Article 370 of its special provisions, the BJP has undermined these nuanced and extremely critical democratic processes. Simultaneously, the State has been carved up into two Union Territories with J&K having a legislature and Ladakh without it. The unprecedented step of reorganizing a State and divesting it of its legislative authority without even a semblance of consultation with the stakeholders sets a dangerous precedent underlined by several regional groups and political parties, particularly the DMK and the MDMK. It is possible that the BJP would reap rich political dividends for this muscular policy. But the Centre would be responsible for the escalation of violence in the Valley where all doors for political engagement and democratic exchange seem to have been closed down for good. Without meaningful participation of the people, any such unilateral integration can remain at best territorial.

**Question 55 :**

Which among the following is SIMILAR in meaning to the word 'pandering' as used in the passage?

**Difficulty : Moderate****Average Time : 230 Seconds****Options :**

1. Pondering
2. Figuring
3. Terming
4. Satisfying
5. None of the above

**Solution :**

The correct answer is **Option 4** i.e. **Satisfying**.

**The meaning of the given words is:**

- **Pandering:** Trying to please or appeal to someone's preferences or desires, often in a disingenuous or insincere manner.
- **Figuring:** Engaging in the process of understanding, solving, or calculating something; trying to make sense of a situation or problem.
- **Terming:** Giving a specific name, label, or term to something; referring to or describing something using particular language.
- **Satisfying:** Providing fulfillment, gratification, or contentment; meeting or exceeding expectations or desires.
- **Pondering:** Engaging in deep or thoughtful consideration or reflection; contemplating or mulling over something.

Thus, the most appropriate synonym for the given word is **Satisfying**.

**Comprehension :**

Read the passage carefully and answer the questions that follow. The passage of a statutory resolution and a Bill in Parliament — “abrogating” Article 370 which confers special political status on Jammu and Kashmir, and bifurcating the State into two Union Territories — has robbed the Kashmir Valley of its political autonomy, or whatever remains of it after all these years. It may deepen the State’s trust deficit vis-a-vis the Centre. The “abrogation” of Article 370, being hailed as a “glorious” move, is itself a misnomer. “Amending” or “abrogating” Article 370 is a Constitutional improbability; the amending provision of Article 368 says no Constitutional amendments have effect in relation to J&K unless applied by Order of the President under Article 370 that requires the concurrence of the State’s legislature and ratification by its Constituent Assembly. The moves on Monday can be seen as an exercise in political optics, pandering to a certain majoritarian sentiment. What the Centre has done is to shred even the garb of democracy and spirit of dialogue that successive governments felt was important to engage the people of Kashmir. Through as many as 45 Presidential Orders, the most critical being the Order of 1954, Article 370 has already been divested of its spirit. Secessionist elements and some Indian Constitutional experts have cited this gradual advance of the Union as the conquest of the Valley by stealth.



What even this controversial process of assimilation, with Article 370 in place, has done is to achieve the growth of local political engagement. It legitimises a pan-Indian sentiment in the Valley where the secessionists would like to portray India as a mere occupational force. Indeed, there are several other provisions in the Constitution such as Article 371(A), 371(G), 371(B), 371(C) that validate indigenous political forces in States like Nagaland, Mizoram, Assam, Manipur et al. This asymmetric form of federalism has its global parallels in the substantial autonomy enjoyed by Scotland and Wales and Northern Ireland within Great Britain. The protests in Hong Kong affirm the relevance of democratic processes inherent in the one country-two systems followed even by China. By robbing Article 370 of its special provisions, the BJP has undermined these nuanced and extremely critical democratic processes. Simultaneously, the State has been carved up into two Union Territories with J&K having a legislature and Ladakh without it. The unprecedented step of reorganizing a State and divesting it of its legislative authority without even a semblance of consultation with the stakeholders sets a dangerous precedent underlined by several regional groups and political parties, particularly the DMK and the MDMK. It is possible that the BJP would reap rich political dividends for this muscular policy. But the Centre would be responsible for the escalation of violence in the Valley where all doors for political engagement and democratic exchange seem to have been closed down for good. Without meaningful participation of the people, any such unilateral integration can remain at best territorial.

**Question 56 :**

Which among the following is/are correct as per the passage regarding the decision taken by the Government of India to revoke Article 370 of the Indian Constitution? I. Jammu and Kashmir will be a Union Territory with a legislature whereas Ladakh will not have the same. II. This decision will help the separatists in the valley to portray India as a force working against the interests of the valley people. III. This decision will not stand in the court of law and there has already been a petition in the Supreme Court against it.

Difficulty : Moderate

Average Time : 221 Seconds

**Options :**

1. Both I and II
2. Both II and III
3. Both I and III
4. Only III
5. All I, II and III

**Solution :**

The correct answer is **Option 1** i.e. **Both I and II**.

As per the passage:



**Statement I is correct.** It is mentioned in the passage that *'The passage of a statutory resolution and a Bill in Parliament — "abrogating" Article 370 which confers special political status on Jammu and Kashmir, and bifurcating the State into two Union Territories — has robbed the Kashmir Valley of its political autonomy, or whatever remains of it after all these years.'* It clearly mentions the given statement.

- **Statement II is also correct** since it has been stated in the passage that the decision taken unilaterally by the Indian government is actually going to hurt the sentiment of the people of Jammu and Kashmir. The separatists there will take this opportunity to brainwash the people there against the interests of the valley people.

Hence, the correct answer is **Option 1 i.e. Both I and II.**

### Comprehension :

Read the passage carefully and answer the questions that follow. The passage of a statutory resolution and a Bill in Parliament — "abrogating" Article 370 which confers special political status on Jammu and Kashmir, and bifurcating the State into two Union Territories — has robbed the Kashmir Valley of its political autonomy, or whatever remains of it after all these years. It may deepen the State's trust deficit vis-a-vis the Centre. The "abrogation" of Article 370, being hailed as a "glorious" move, is itself a misnomer. "Amending" or "abrogating" Article 370 is a Constitutional improbability; the amending provision of Article 368 says no Constitutional amendments have effect in relation to J&K unless applied by Order of the President under Article 370 that requires the concurrence of the State's legislature and ratification by its Constituent Assembly. The moves on Monday can be seen as an exercise in political optics, pandering to a certain majoritarian sentiment. What the Centre has done is to shred even the garb of democracy and spirit of dialogue that successive governments felt was important to engage the people of Kashmir. Through as many as 45 Presidential Orders, the most critical being the Order of 1954, Article 370 has already been divested of its spirit. Secessionist elements and some Indian Constitutional experts have cited this gradual advance of the Union as the conquest of the Valley by stealth. What even this controversial process of assimilation, with Article 370 in place, has done is to achieve the growth of local political engagement. It legitimises a pan-Indian sentiment in the Valley where the secessionists would like to portray India as a mere occupational force. Indeed, there are several other provisions in the Constitution such as Article 371(A), 371(G), 371(B), 371(C) that validate indigenous political forces in States like Nagaland, Mizoram, Assam, Manipur et al. This asymmetric form of federalism has its global parallels in the substantial autonomy enjoyed by Scotland and Wales and Northern Ireland within Great Britain. The protests in Hong Kong affirm the relevance of democratic processes inherent in the one country-two systems followed even by China. By robbing Article 370 of its special provisions, the BJP has undermined these nuanced and extremely critical democratic processes. Simultaneously, the State has been carved up into two Union Territories with J&K having a legislature and Ladakh without it. The unprecedented step of reorganizing a State and divesting it of its legislative authority without even a semblance of consultation with the stakeholders sets a dangerous precedent underlined by several regional groups and political parties, particularly the DMK and the MDMK. It is possible that the BJP would reap rich political dividends for this muscular policy. But the Centre would be responsible for the escalation of violence in the Valley where all doors for political engagement and democratic exchange seem to have been closed down for good. Without meaningful participation of the people, any such unilateral integration can remain at best territorial.



## Question 57 :

Which among the following is SIMILAR in meaning to the word 'misnomer' as used in the passage?

Difficulty : Moderate

Average Time : 215 Seconds

### Options :

1. Understanding
2. Utilization
3. Misleading
4. Mutual
5. None of the above

### Solution :

The correct answer is **Option 3** i.e. **misleading**.

The meaning of the given words is:

- **Misnomer**: An inaccurate or incorrect name or term.
- **Misleading**: Creating a wrong impression or leading someone to have a false understanding.
- **Understanding**: Comprehension or awareness of something; a cooperative relationship characterized by empathy and agreement.
- **Utilizing**: Making use of or employing something for a specific purpose or advantage.
- **Mutual**: Shared or experienced in common by two or more parties; reciprocal or equal relationship.

Thus, the most appropriate synonym for the given word is **misleading**.

## Question 58 :

In the following question, a sentence is given with certain words in bold. Choose the pairs of such words which need to be interchanged so as to make the sentence grammatically correct and meaningful. There is a perception that the government's fight against crony (A) capitalism, black money, and corruption has led to restrictive (B) economic policies and, worse, a crackdown (C) on businessmen (D).

Difficulty : Moderate

Average Time : 78 Seconds

### Options :

1. A-D
2. B-C



C-D

4. A-B

5. All are correct

**Solution :**

The correct answer is **Option 5** i.e. **All are correct**.

- In the given sentence, all the words are placed correctly. Thus, there is no need for rearrangement.

Hence, the correct answer is **Option 5** i.e. **All are correct**.

**Question 59 :**

A and B started a business with initial investments in the ratio 5 : 7. After one year their profits were in the ratio 1 : 2 . If the period for A's investment was 7 months, B invested the money for how many months:

**Difficulty : Moderate**

**Average Time : 51 Seconds**

**Options :**

1. 6 months
2.  $2\frac{1}{2}$  months
3. 10 months
4. 4 months
5. 7 months

**Solution :**

The correct answer is **option 3** i.e. **10 months**.

Let B invest money for x months

$$5 \times 7 \hat{=} 7 \times x = 1 \hat{=} 2$$

$$35 \hat{=} 7x = 1 \hat{=} 2$$

$$7x = 35 \times 2$$

$$x = 10 \text{ months}$$

**Comprehension :**

Directions (61-65): In each of these questions, two equations I and II are given. You have to solve both the equations and give answer

**Question 60 :**

The circumference of the two circles is 132 m and 176 m respectively. What is the difference between the area of a larger circle and a smaller circle? (in m<sup>2</sup>)

**Difficulty : Moderate****Average Time : 56 Seconds****Options :**

1. 1052
2. 1128
3. 1258
4. 1078
5. 1528

**Solution :**

The correct answer is **option 4** i.e. **1078**.

Let radius of smaller & larger circles be  $r_1$  &  $r_2$ , respectively

$$2\pi r_1 = 132 \quad r_1 = 21 \text{ m}$$

$$2\pi r_2 = 176 \quad r_2 = 28 \text{ m}$$

$$\text{Required difference} = \pi(r_2^2 - r_1^2) = \frac{22}{7} \times 49 \times 7 = 1078 \text{ m}^2$$

**Question 61 :**

In the given question, four words are printed in bold and are numbered A, B, C, and D. The position of some highlighted words may be incorrect and need to be exchanged with another highlighted to make the sentence correct. Find the words that need to be exchanged. In case the given sentence is correct, mark option 5 i.e. 'No error' as your answer. The city used to be the extensive, splendid and opulent (A)/ capital of independent retains (B)/ of the same name, but now sovereignty (C)/ only the vestiges of its former grandeur (D).

**Difficulty : Moderate****Average Time : 69 Seconds****Options :**

1. A-D
2. B-C
3. A-C
4. C-D



No Error

**Solution :**

The correct answer is **Option 2** i.e. **B-C**.

- The reason why '**B-C**' seems to be the correct replacement for words is their meanings and contextual reference.
- The sentence talks about a city and its sovereignty. Upon reading the sentence it can clearly be inferred that the words at B-C do not fit as per the context and grammar. So these should be interchanged.

**The correct sentence would be:** The city used to be the extensive, splendid and **opulent** capital of independent **sovereignty** of the same name, but now **retains** only the vestiges of its former **grandeur**.

Hence, the correct answer is **Option 2** i.e. **B-C**.

**Question 62 :**

Five sentences numbered A, B, C, D and E are given below. Four of them can be put together to form a meaningful and coherent short paragraph. Identify the odd one out. A. India's constitution banned caste discrimination and early governments introduced quotas to provide fairer allocation of jobs and education, but caste remains a powerful factor in politics. B. Although the U.S. has been a strong proponent of democracy, it did not invent democracy. C. Another important ancient Greek concept that influenced the formation of the United States government was the written constitution. D. The Greeks are often credited with pioneering a democratic government that went on to influence the structure of the United States. E. Like The Constitution of the Athenians, the U.S. Constitution is a vital document which lays out the government's structure and how the checks and balances of power within it relate to one another.

Difficulty : Moderate

Average Time : 106 Seconds

**Options :**

1. A
2. B
3. C
4. D
5. E

**Solution :**

The correct option is **option 1** i.e. **A**.

- All the sentences, except sentence A centre around Greek Influence on U.S. Democracy.
- Sentence A on the other hand quotes on democracy in India. The sentence, though, can be seen as an integral part of the whole topic of democracy, is not required in the given paragraph as it breaks the chain of thoughts.

Hence, sentence A is the misfit sentence here.

Clearly, **option A** is the correct answer.

**Comprehension :**

Direction: Read the given information carefully and answer the following questions. Eight people J, K, L, M, N, O, P, and Q are sitting in a linear row and facing north but not necessarily in the same order. Not more than two people sit to the left of P. M sits second to the right of P. Two people sit between M and L who is not a neighbor of P. Q sits immediately left of O and no one sits at the end. K sits second to the left of J. N doesn't sit to the right of K.

**Question 63 :**

Who among the following sits at the right end?

**Difficulty : Moderate**

**Average Time : 82 Seconds**

**Options :**

1. J
2. K
3. L
4. M
5. N

**Solution :**

The correct answer is **Option 3** i.e. **L**

1. Not more than two people sit to the left of P. Here, we have 3 Cases i.e. Case 1, Case 2, and Case 3.
2. M sits second to the right of P.
3. Two people sit between M and L who is not a neighbor of P.
4. Q sits immediately left of O and no one sits at the end.

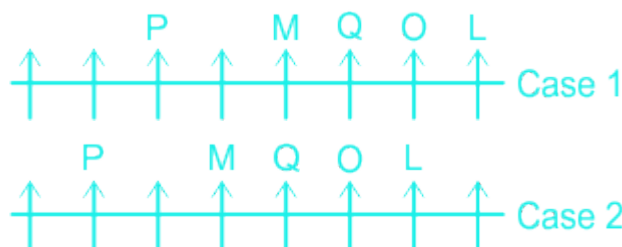

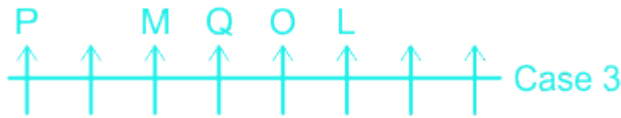

5. K sits second to the left of J.

Now, we can eliminate Case 3.

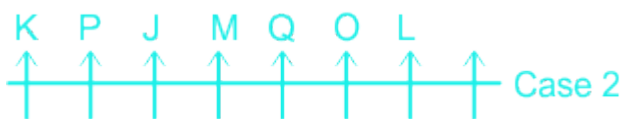
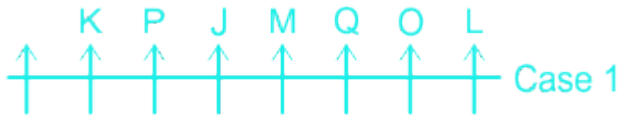

6. N doesn't sit to the right of K.

Now, we can eliminate Case 2.



This is our final arrangement.

Clearly, L sits at the right end.

Hence, the correct answer is **L**.

### Comprehension :

Direction: Read the given information carefully and answer the following questions. 8 people L, M, N, O, P, Q, R, and S book their flight tickets in 4 different months May, June, July, and August on 2 different dates 6 and 29 but not necessarily in the same order. S books the ticket in the month having 30 days. Only one person books the ticket between S and M. Only two persons book the ticket between M and O who books the ticket before M. R books the ticket immediately before L but in different months. P books the ticket before N but after Q.

### Question 64 :

How many people book a ticket between N and S?

Difficulty : Moderate

Average Time : 119 Seconds

### Options :

1. 2

2. 3

4

4. 5

5. 1

**Solution :**

The correct answer is **Option 3** i.e. 4

1. S books the ticket in the month having 30 days. (Here, we have two Cases i.e. Case 1 and Case 2)
2. Only one person books the ticket between S and M. (Now, we have 4 cases Case 1, Case 1a, Case 2, and Case 2a)

Months	Dates	Case 1	Case 1a	Case 2	Case 2a
May (31)	6	M			
	29			M	
June (30)	6	S	S		
	29			S	S
July (31)	6		M		
	29				M
August (31)	6				
	29				

3. Only two persons book the ticket between M and O who books the ticket before M.

Now, we can eliminate Case 1 and Case 2.

Months	Dates	Case 1a	Case 2a
May (31)	6		
	29	O	
June (30)	6	S	O

	29		S
July (31)	6	M	
	29		M
August (31)	6		
	29		

4. R books the ticket immediately before L but in different months.

Now, we can eliminate Case 2(a).

Months	Dates	Case 1a
May (31)	6	
	29	O
June (30)	6	S
	29	
July (31)	6	M
	29	R
August (31)	6	L
	29	

5. P books the ticket before N but after Q.

Months	Dates	Case 1a
May (31)	6	Q
	29	O
June (30)	6	S
	29	P
July (31)	6	M
	29	R
August (31)	6	L



	29	N
--	----	---

This is our final arrangement.

Clearly, 4 people book a ticket between N and S.

Hence, the correct answer is "4".

**Comprehension :**

Direction: Read the given information carefully and answer the following questions. 8 people L, M, N, O, P, Q, R, and S book their flight tickets in 4 different months May, June, July, and August on 2 different dates 6 and 29 but not necessarily in the same order. S books the ticket in the month having 30 days. Only one person books the ticket between S and M. Only two persons book the ticket between M and O who books the ticket before M. R books the ticket immediately before L but in different months. P books the ticket before N but after Q.

**Question 65 :**

Which one is odd?

**Difficulty : Moderate**

**Average Time : 235 Seconds**

**Options :**

- 1. O
- 2. P
- 3. M
- 4. R
- 5. N

**Solution :**

The correct answer is **Option 3** i.e. **M**

- 1. S books the ticket in the month having 30 days. (Here, we have two Cases i.e. Case 1 and Case 2)
- 2. Only one person books the ticket between S and M. (Now, we have 4 cases Case 1, Case 1a, Case 2, and Case 2a)

Months	Dates	Case 1	Case 1a	Case 2	Case 2a
May (31)	6	M			
	29			M	
June (30)	6	S	S		

	29			S	S
July (31)	6		M		
	29				M
August (31)	6				
	29				

3. Only two persons book the ticket between M and O who books the ticket before M.

Now, we can eliminate Case 1 and Case 2.

Months	Dates	Case 1a	Case 2a
May (31)	6		
	29	O	
June (30)	6	S	O
	29		S
July (31)	6	M	
	29		M
August (31)	6		
	29		

4. R books the ticket immediately before L but in different months.

Now, we can eliminate Case 2(a).

Months	Dates	Case 1a
May (31)	6	
	29	O
June (30)	6	S
	29	
July (31)	6	M
	29	R

August (31)	6	L
	29	

5. P books the ticket before N but after Q.

Months	Dates	Case 1a
May (31)	6	Q
	29	O
June (30)	6	S
	29	P
July (31)	6	M
	29	R
August (31)	6	L
	29	N

This is our final arrangement.

Except for M, all others book a ticket on 29.

Hence, the correct answer is "M".

### Comprehension :

Direction: Read the given information carefully and answer the following questions. 8 people L, M, N, O, P, Q, R, and S book their flight tickets in 4 different months May, June, July, and August on 2 different dates 6 and 29 but not necessarily in the same order. S books the ticket in the month having 30 days. Only one person books the ticket between S and M. Only two persons book the ticket between M and O who books the ticket before M. R books the ticket immediately before L but in different months. P books the ticket before N but after Q.

### Question 66 :

Who among the following books the ticket immediately after L?

Difficulty : Moderate

Average Time : 238 Seconds

### Options :

1. M

2. N

- O
- 4. P
- 5. Q

**Solution :**

The correct answer is **Option 2** i.e. **N**

1. S books the ticket in the month having 30 days. (Here, we have two Cases i.e. Case 1 and Case 2)
2. Only one person books the ticket between S and M. (Now, we have 4 cases Case 1, Case 1a, Case 2, and Case 2a)

Months	Dates	Case 1	Case 1a	Case 2	Case 2a
May (31)	6	M			
	29			M	
June (30)	6	S	S		
	29			S	S
July (31)	6		M		
	29				M
August (31)	6				
	29				

3. Only two persons book the ticket between M and O who books the ticket before M.

Now, we can eliminate Case 1 and Case 2.

Months	Dates	Case 1a	Case 2a
May (31)	6		
	29	O	
June (30)	6	S	O
	29		S
July (31)	6	M	
	29		M

August (31)	6		
	29		

4. R books the ticket immediately before L but in different months.

Now, we can eliminate Case 2(a).

Months	Dates	Case 1a
May (31)	6	
	29	O
June (30)	6	S
	29	
July (31)	6	M
	29	R
August (31)	6	L
	29	

5. P books the ticket before N but after Q.

Months	Dates	Case 1a
May (31)	6	Q
	29	O
June (30)	6	S
	29	P
July (31)	6	M
	29	R
August (31)	6	L
	29	N

This is our final arrangement.

Clearly, N books the ticket immediately after L.

Hence, the correct answer is "N".

### Comprehension :

Direction: Read the given information carefully and answer the following questions. 8 people L, M, N, O, P, Q, R, and S book their flight tickets in 4 different months May, June, July, and August on 2 different dates 6 and 29 but not necessarily in the same order. S books the ticket in the month having 30 days. Only one person books the ticket between S and M. Only two persons book the ticket between M and O who books the ticket before M. R books the ticket immediately before L but in different months. P books the ticket before N but after Q.

### Question 67 :

Who among the following books the ticket on 29 May?

Difficulty : Moderate

Average Time : 238 Seconds

### Options :

1. S
2. P
3. M
4. Q
5. O

### Solution :

The correct answer is **Option 5** i.e. **O**

1. S books the ticket in the month having 30 days. (Here, we have two Cases i.e. Case 1 and Case 2)
2. Only one person books the ticket between S and M. (Now, we have 4 cases Case 1, Case 1a, Case 2, and Case 2a)

Months	Dates	Case 1	Case 1a	Case 2	Case 2a
May (31)	6	M			
	29			M	
June (30)	6	S	S		
	29			S	S
July (31)	6		M		
	29				M

August (31)	6				
	29				

3. Only two persons book the ticket between M and O who books the ticket before M.

Now, we can eliminate Case 1 and Case 2.

Months	Dates	Case 1a	Case 2a
May (31)	6		
	29	O	
June (30)	6	S	O
	29		S
July (31)	6	M	
	29		M
August (31)	6		
	29		

4. R books the ticket immediately before L but in different months.

Now, we can eliminate Case 2(a).

Months	Dates	Case 1a
May (31)	6	
	29	O
June (30)	6	S
	29	
July (31)	6	M
	29	R
August (31)	6	L
	29	

5. P books the ticket before N but after Q.

Months	Dates	Case 1a
May (31)	6	Q
	29	O
June (30)	6	S
	29	P
July (31)	6	M
	29	R
August (31)	6	L
	29	N

This is our final arrangement.

Clearly, O books the ticket on 29 May.

Hence, the correct answer is "O".

### Comprehension :

Direction: Read the given information carefully and answer the following questions. 8 people L, M, N, O, P, Q, R, and S book their flight tickets in 4 different months May, June, July, and August on 2 different dates 6 and 29 but not necessarily in the same order. S books the ticket in the month having 30 days. Only one person books the ticket between S and M. Only two persons book the ticket between M and O who books the ticket before M. R books the ticket immediately before L but in different months. P books the ticket before N but after Q.

### Question 68 :

Which one is correct?

Difficulty : Moderate

Average Time : 236 Seconds

### Options :

1. S - May
2. Q - July
3. R - August
4. L - August
5. O - June



**Solution :**

The correct answer is **Option 4** i.e. **L - August**

- S books the ticket in the month having 30 days. (Here, we have two Cases i.e. Case 1 and Case 2)
- Only one person books the ticket between S and M. (Now, we have 4 cases Case 1, Case 1a, Case 2, and Case 2a)

Months	Dates	Case 1	Case 1a	Case 2	Case 2a
May (31)	6	M			
	29			M	
June (30)	6	S	S		
	29			S	S
July (31)	6		M		
	29				M
August (31)	6				
	29				

- Only two persons book the ticket between M and O who books the ticket before M.

Now, we can eliminate Case 1 and Case 2.

Months	Dates	Case 1a	Case 2a
May (31)	6		
	29	O	
June (30)	6	S	O
	29		S
July (31)	6	M	
	29		M
August (31)	6		
	29		

- R books the ticket immediately before L but in different months.

Now, we can eliminate Case 2(a).

Months	Dates	Case 1a
May (31)	6	
	29	O
June (30)	6	S
	29	
July (31)	6	M
	29	R
August (31)	6	L
	29	

5. P books the ticket before N but after Q.

Months	Dates	Case 1a
May (31)	6	Q
	29	O
June (30)	6	S
	29	P
July (31)	6	M
	29	R
August (31)	6	L
	29	N

This is our final arrangement.

Clearly, L - August is correct.

Hence, the correct answer is "**L - August**".

### Comprehension :

Direction: Read the given information carefully and answer the following questions. Eight people L, M, N, O, P, Q, R, and S are sitting on a circular table and facing inside but not necessarily in the same order. L sits two places away from O. Two persons sit between L and S who is not a neighbor of O. Q sits opposite M who is not a neighbor of L. N sits third to the right of R who is not a neighbor of Q.

**Question 69 :**

How many people sit between P and R from the right of P?

Difficulty : Moderate

Average Time : 236 Seconds

**Options :**

1. 1
2. 2
3. 3
4. 4
5. 5

**Solution :**

The correct answer is **Option 2** i.e. **2**

1. L sits two places away from O. Here, we have two cases i.e. Case 1 and Case 2.
2. Two persons sit between L and S who is not a neighbor of O.
3. Q sits opposite M who is not a neighbor of L.

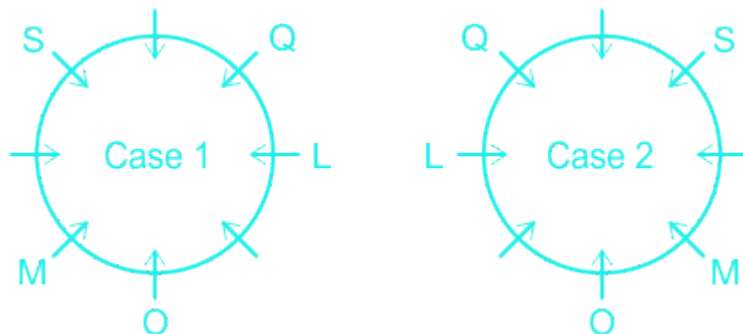

4. N sits third to the right of R who is not a neighbor of Q.

Now, we can eliminate Case 2.

So, the remaining person P sits between M and S.

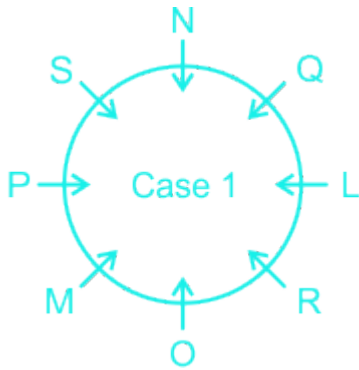

This is our final arrangement.

Clearly, 2 people sit between P and R from the right of P.

Hence, the correct answer is **2**.

**Comprehension :**

Direction: Read the given information carefully and answer the following questions. Eight people L, M, N, O, P, Q, R, and S are sitting on a circular table and facing inside but not necessarily in the same order. L sits two places away from O. Two persons sit between L and S who is not a neighbor of O. Q sits opposite M who is not a neighbor of L. N sits third to the right of R who is not a neighbor of Q.

**Question 70 :**

Who among the following sits second to the right of Q?

**Difficulty : Moderate**

**Average Time : 94 Seconds**

**Options :**

- 1. L
- 2. M
- 3. S
- 4. N
- 5. O

**Solution :**

The correct answer is **Option 3** i.e. **S**

- 1. L sits two places away from O. Here, we have two cases i.e. Case 1 and Case 2.
- 2. Two persons sit between L and S who is not a neighbor of O.

3. Q sits opposite M who is not a neighbor of L.

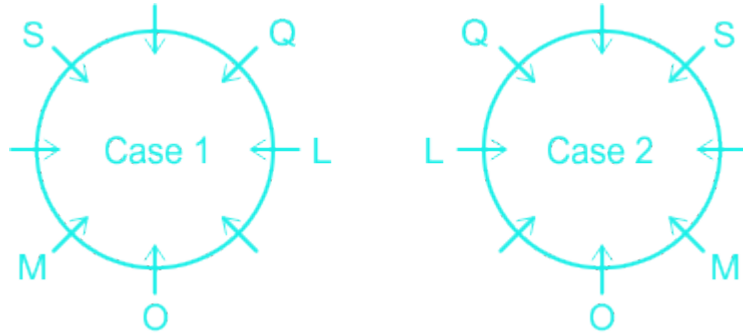

4. N sits third to the right of R who is not a neighbor of Q.

Now, we can eliminate Case 2.

So, the remaining person P sits between M and S.

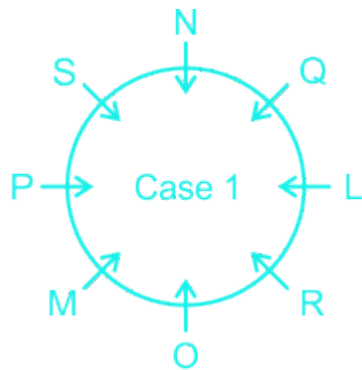

This is our final arrangement.

Clearly, S sits second to the right of Q.

Hence, the correct answer is **S**.

**Comprehension :**

Direction: Read the given information carefully and answer the following questions. Eight people L, M, N, O, P, Q, R, and S are sitting on a circular table and facing inside but not necessarily in the same order. L sits two places away from O. Two persons sit between L and S who is not a neighbor of O. Q sits opposite M who is not a neighbor of L. N sits third to the right of R who is not a neighbor of Q.

**Question 71 :**

Which among the following pair is odd?

Difficulty : Moderate

Average Time : 94 Seconds

**Options :**

1. S - N
2. M - P
3. R - O
4. S - Q
5. Q - L

**Solution :**

The correct answer is **Option 4** i.e. **S - Q**

1. L sits two places away from O. Here, we have two cases i.e. Case 1 and Case 2.
2. Two persons sit between L and S who is not a neighbor of O.
3. Q sits opposite M who is not a neighbor of L.

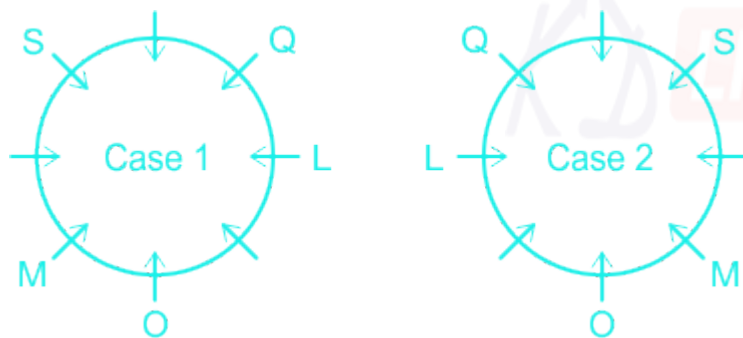

4. N sits third to the right of R who is not a neighbor of Q.

Now, we can eliminate Case 2.

So, the remaining person P sits between M and S.

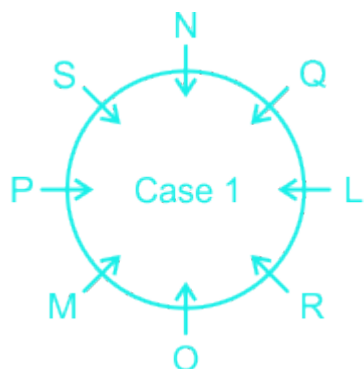



This is our final arrangement.

Except for S - Q, all others sit adjacent to each other.

Hence, the correct answer is **S - Q**.

**Comprehension :**

Direction: Read the given information carefully and answer the following questions. Eight people L, M, N, O, P, Q, R, and S are sitting on a circular table and facing inside but not necessarily in the same order. L sits two places away from O. Two persons sit between L and S who is not a neighbor of O. Q sits opposite M who is not a neighbor of L. N sits third to the right of R who is not a neighbor of Q.

**Question 72 :**

Which of the following statement/s is/are correct? I. S sits opposite R. II. L sits second to the left of O. III. Q sits immediately left of N.

Difficulty : Moderate

Average Time : 104 Seconds

**Options :**

1. Only I
2. Only I and II
3. Only II and III
4. Only I and III
5. All I, II, and III

**Solution :**

The correct answer is **Option 4** i.e. **Only I and III**

1. L sits two places away from O. Here, we have two cases i.e. Case 1 and Case 2.
2. Two persons sit between L and S who is not a neighbor of O.
3. Q sits opposite M who is not a neighbor of L.

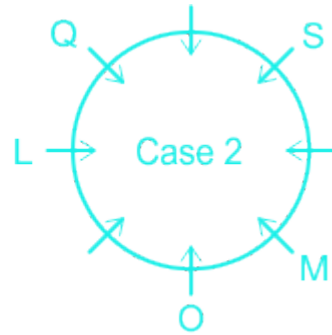
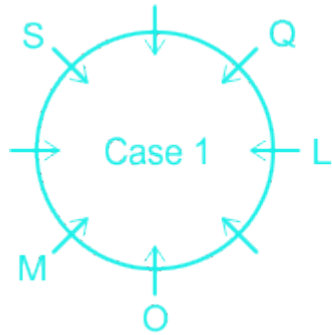

4. N sits third to the right of R who is not a neighbor of Q.

Now, we can eliminate Case 2.

So, the remaining person P sits between M and S.

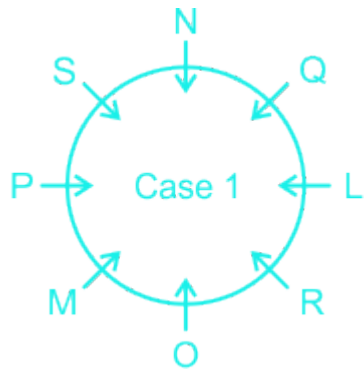

This is our final arrangement.

Clearly, Only I and III are the correct statements.

Hence, the correct answer is **Only I and III.**

### Comprehension :

Direction: Read the given information carefully and answer the following questions. Eight people L, M, N, O, P, Q, R, and S are sitting on a circular table and facing inside but not necessarily in the same order. L sits two places away from O. Two persons sit between L and S who is not a neighbor of O. Q sits opposite M who is not a neighbor of L. N sits third to the right of R who is not a neighbor of Q.

### Question 73 :

Who among the following sits third to the left of L?

Difficulty : Moderate

Average Time : 100 Seconds

Options :



- S
- 2. N
- 3. Q
- 4. R
- 5. M

**Solution :**

The correct answer is **Option 5** i.e. **M**

1. L sits two places away from O. Here, we have two cases i.e. Case 1 and Case 2.
2. Two persons sit between L and S who is not a neighbor of O.
3. Q sits opposite M who is not a neighbor of L.

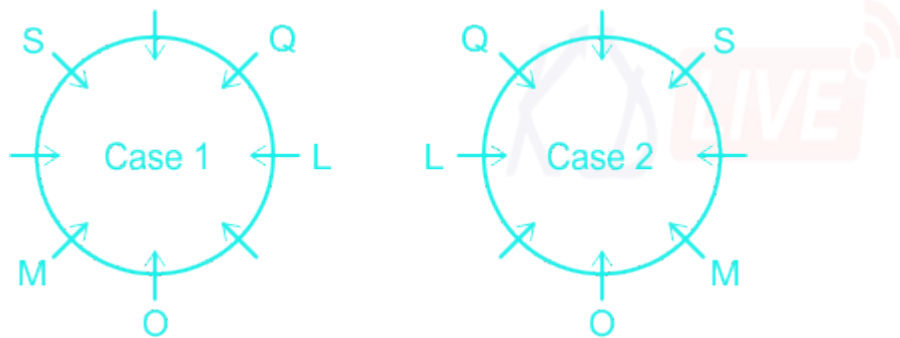

4. N sits third to the right of R who is not a neighbor of Q.
- Now, we can eliminate Case 2.

So, the remaining person P sits between M and S.

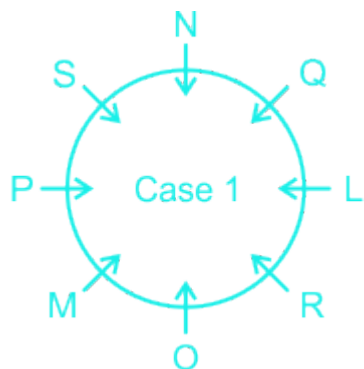

This is our final arrangement.

Clearly, M sits third to the left of L.

Hence, the correct answer is **M**.

**Comprehension :**

Direction: Read the given information carefully and answer the following questions. Eight people J, K, L, M, N, O, P, and Q are sitting in a linear row and facing north but not necessarily in the same order. Not more than two people sit to the left of P. M sits second to the right of P. Two people sit between M and L who is not a neighbor of P. Q sits immediately left of O and no one sits at the end. K sits second to the left of J. N doesn't sit to the right of K.

**Question 74 :**

Who among the following sits third to the left of J?

**Difficulty : Moderate****Average Time : 101 Seconds****Options :**

1. K
2. P
3. O
4. L
5. N

**Solution :**

The correct answer is **Option 5** i.e. **N**

1. Not more than two people sit to the left of P. Here, we have 3 Cases i.e. Case 1, Case 2, and Case 3.
2. M sits second to the right of P.
3. Two people sit between M and L who is not a neighbor of P.
4. Q sits immediately left of O and no one sits at the end.

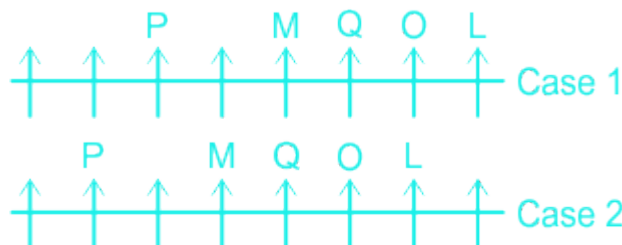

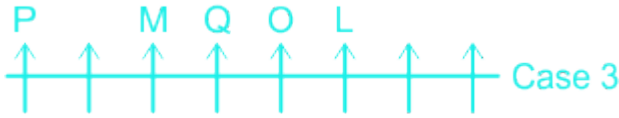

5. K sits second to the left of J.

Now, we can eliminate Case 3.

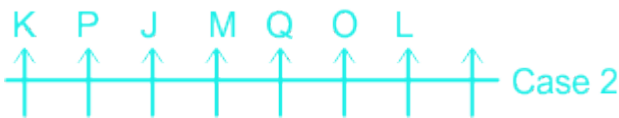
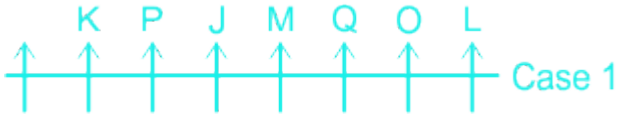

6. N doesn't sit to the right of K.

Now, we can eliminate Case 2.

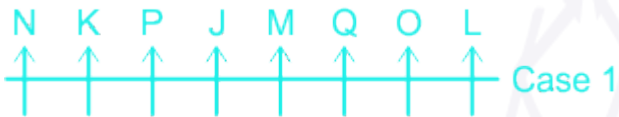

This is our final arrangement.

Clearly, N sits third to the left of J.

Hence, the correct answer is **N**.

**Comprehension :**

Direction: Read the given information carefully and answer the following questions. Eight people J, K, L, M, N, O, P, and Q are sitting in a linear row and facing north but not necessarily in the same order. Not more than two people sit to the left of P. M sits second to the right of P. Two people sit between M and L who is not a neighbor of P. Q sits immediately left of O and no one sits at the end. K sits second to the left of J. N doesn't sit to the right of K.

**Question 75 :**

How many people sit between N and Q?

Difficulty : Moderate

Average Time : 118 Seconds

**Options :**

1. 2

2. 3

4

4. 5

5. More than 5

**Solution :**

The correct answer is **Option 3** i.e. 4

- Not more than two people sit to the left of P. Here, we have 3 Cases i.e. Case 1, Case 2, and Case 3.
- M sits second to the right of P.
- Two people sit between M and L who is not a neighbor of P.
- Q sits immediately left of O and no one sits at the end.

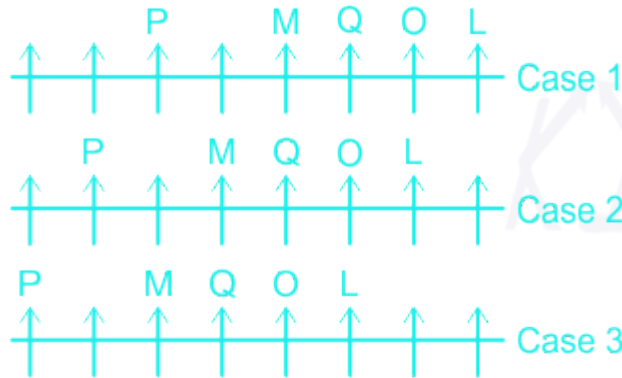

5. K sits second to the left of J.

Now, we can eliminate Case 3.

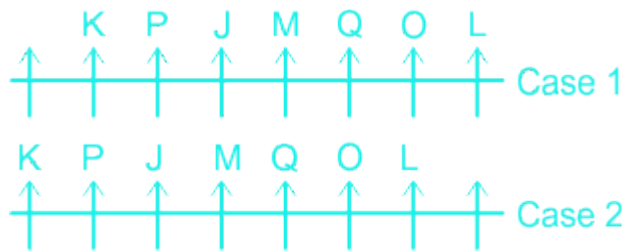

6. N doesn't sit to the right of K.

Now, we can eliminate Case 2.



This is our final arrangement.

Clearly, 4 people sit between N and Q.

Hence, the correct answer is **4**.

**Comprehension :**

Direction: Read the given information carefully and answer the following questions. Eight people J, K, L, M, N, O, P, and Q are sitting in a linear row and facing north but not necessarily in the same order. Not more than two people sit to the left of P. M sits second to the right of P. Two people sit between M and L who is not a neighbor of P. Q sits immediately left of O and no one sits at the end. K sits second to the left of J. N doesn't sit to the right of K.

**Question 76 :**

Which of the following statement/s is/are true? I. K sits second from the left end. II. J sits immediately right of P. III. Q sits to the left of M.

Difficulty : Moderate

Average Time : 122 Seconds

**Options :**

1. Only I and II
2. Only I and III
3. Only II and III
4. All I, II, and III
5. None

**Solution :**

The correct answer is **Option 1** i.e. **Only I and II**

1. Not more than two people sit to the left of P. Here, we have 3 Cases i.e. Case 1, Case 2, and Case 3.
2. M sits second to the right of P.
3. Two people sit between M and L who is not a neighbor of P.
4. Q sits immediately left of O and no one sits at the end.



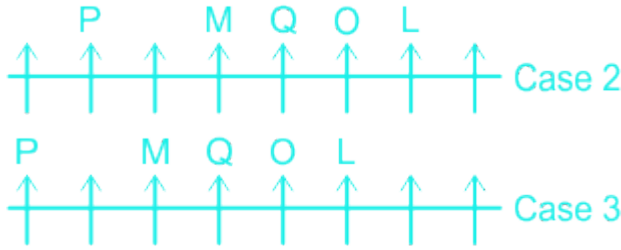

5. K sits second to the left of J.

Now, we can eliminate Case 3.

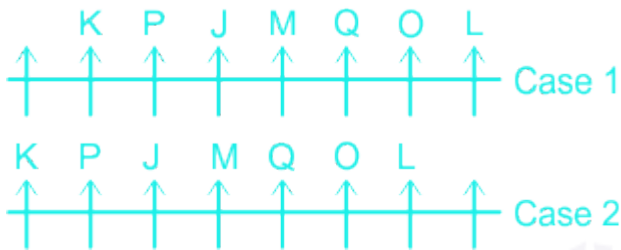

6. N doesn't sit to the right of K.

Now, we can eliminate Case 2.

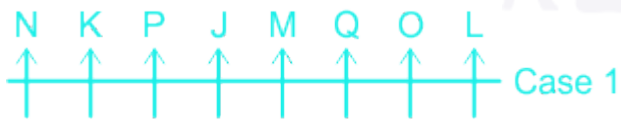

This is our final arrangement.

Clearly, Only I and II follow.

Hence, the correct answer is **Only I and II**.

### Comprehension :

Direction: Read the given information carefully and answer the following questions. Eight people J, K, L, M, N, O, P, and Q are sitting in a linear row and facing north but not necessarily in the same order. Not more than two people sit to the left of P. M sits second to the right of P. Two people sit between M and L who is not a neighbor of P. Q sits immediately left of O and no one sits at the end. K sits second to the left of J. N doesn't sit to the right of K.

### Question 77 :

Who among the following sits second from the right end?

Difficulty : Moderate

Average Time : 123 Seconds

Options :

- Q
- 2. O
- 3. J
- 4. M
- 5. K

**Solution :**

The correct answer is **Option 2** i.e. **O**

1. Not more than two people sit to the left of P. Here, we have 3 Cases i.e. Case 1, Case 2, and Case 3.
2. M sits second to the right of P.
3. Two people sit between M and L who is not a neighbor of P.
4. Q sits immediately left of O and no one sits at the end.

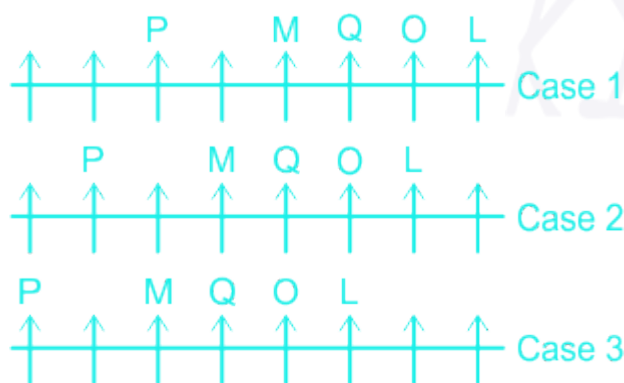

5. K sits second to the left of J.

Now, we can eliminate Case 3.

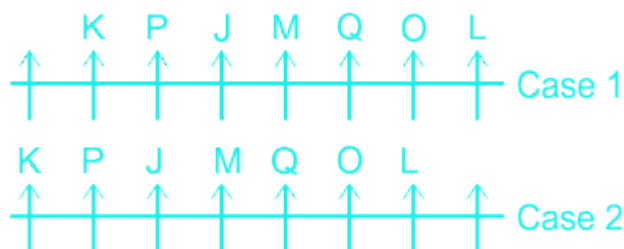

6. N doesn't sit to the right of K.

Now, we can eliminate Case 2.

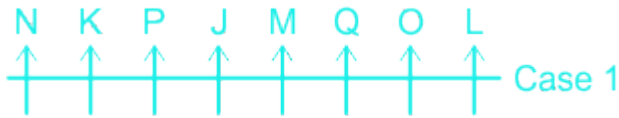

This is our final arrangement.

Clearly, O sits second from the right end.

Hence, the correct answer is **O**.

**Comprehension :**

Directions: Read the following 3-digit-based series and answer the questions. 248 458 493 927 657

**Question 78 :**

If the positions of the second and third digits of each number are interchanged, then which number is the second highest?

Difficulty : Moderate

Average Time : 105 Seconds

**Options :**

1. 248
2. 458
3. 493
4. 927
5. 657

**Solution :**

The correct answer is **Option 5** i.e. **657**

248 458 493 927 657

After interchanging,

284 485 439 972 **675**

Clearly, 675 is the second-highest number.

Hence, the correct answer is **657**.

**Comprehension :**

Directions: Read the following 3-digit-based series and answer the questions. 248 458 493 927 657

**Question 79 :**

What is the multiplication of all the digits of the resultant number formed by the sum of the smallest and third-highest





numbers?

**Difficulty : Moderate**

**Average Time : 45 Seconds**

**Options :**

1. 24

2. 26

3. 28

4. 30

5. 32

**Solution :**

The correct answer is **Option 3** i.e. **28**

248 458 493 927 657

Smallest number = 248

Third highest = 493

Sum = 248 + 493 = 741

Multiplication =  $7 \times 4 \times 1 = 28$

Hence, the correct answer is **28**.

**Comprehension :**

Directions: Read the following 3-digit-based series and answer the questions. 248 458 493 927 657

**Question 80 :**

If 1 is added to the last digit of each of the numbers, how many numbers thus formed will be multiple of 4?

**Difficulty : Moderate**

**Average Time : 46 Seconds**

**Options :**

1. 0

2. 1

3. 2

4. 3



4

**Solution :**

The correct answer is **Option 2** i.e. **1**

$$248 + 1 = 249 = \text{Not divisible by } 4$$

$$458 + 1 = 459 = \text{Not divisible by } 4$$

$$493 + 1 = 494 = \text{Not divisible by } 4$$

$$927 + 1 = 928 \div 4 = 232$$

$$657 + 1 = 658 = \text{Not divisible by } 4$$

Hence, the correct answer is **1**.

**Comprehension :**

Directions: Read the following 3-digit-based series and answer the questions. 248 458 493 927 657

**Question 81 :**

What is the difference between the four times of the second digit of the highest number and two times of the first digit of the lowest number?

**Difficulty : Moderate**

**Average Time : 92 Seconds**

**Options :**

1. 0

2. 1

3. 2

4. 3

5. 4

**Solution :**

The correct answer is **Option 5** i.e. **4**

248 458 493 927 657

The second digit of the highest number = 2

Four times the second digit of the highest number =  $4 \times 2 = 8$



The first digit of the lowest number = 2

Two times the first digit of the lowest number =  $2 \times 2 = 4$

Difference =  $8 - 4 = 4$

Hence, the correct answer is **4**.

**Comprehension :**

Directions: Read the following 3-digit-based series and answer the questions. 248 458 493 927 657

**Question 82 :**

If we multiply the first and third digits within the number then the resultant of which number is the second smallest?

Difficulty : Moderate

Average Time : 53 Seconds

**Options :**

1. 248
2. 458
3. 493
4. 927
5. 657

**Solution :**

The correct answer is **Option 1** i.e. **248**

$$248 = 2 \times 8 = 16$$

$$458 = 4 \times 8 = 32$$

$$493 = 4 \times 3 = 12$$

$$927 = 9 \times 7 = 63$$

$$657 = 6 \times 7 = 42$$

Hence, the correct answer is **248**.

**Comprehension :**

Direction: In the following question three statements are followed by three conclusions numbered I, II, and III. You have to take the given statements to be true even if they seem to be at variance from commonly known facts. Read all the statements and decide which of the given conclusion/conclusions logically follows from the given statements.

**Question 83 :**



Statements: Only a few B are R Some R is C No C is D Conclusions: I. Some B are D II. Some R is not D III. All C are B

Difficulty : Moderate

Average Time : 61 Seconds

Options :

1. Only Conclusion I follows
2. Only Conclusion II follows
3. Only Conclusion III follows
4. Both Conclusions I and II follow
5. All follow

Solution :

The correct answer is **Option 2** i.e. **Only Conclusion II follows**

The Venn diagram for the given statements is:

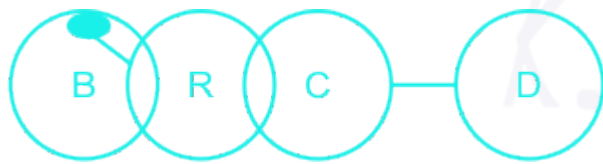

Conclusions:

- I. Some B are D **False** (It is possible but not definite as there is no direct relation between the elements)
- II. Some R is not D **True** (As some R is C and No C is D so Some R is not D is true.)
- III. All C are B **False** (It is possible but not definite as there is no direct relation between the elements)

Hence, the correct answer is **Only Conclusion II follows**.

Comprehension :

Direction: In the following question three statements are followed by three conclusions numbered I, II, and III. You have to take the given statements to be true even if they seem to be at variance from commonly known facts. Read all the statements and decide which of the given conclusion/conclusions logically follows from the given statements.

Question 84 :

Statements: Only a few M are R Some R are S Only a few S are W Conclusions: I. Some W are M II. Some M are S III. Some R is not W

Difficulty : Moderate

Average Time : 97 Seconds

**Options :**

1. Only Conclusion I follows
2. Only Conclusion II follows
3. Both Conclusion I and II follow
4. Both Conclusion I and III follow
5. None follows

**Solution :**

The correct answer is **Option 5** i.e. **None follows**

The Venn diagram for the given statements is:

**Conclusions:**

- I. Some W are M **False** (It is possible but not definite as there is no direct relation between the elements)
- II. Some M are S **False** (It is possible but not definite as there is no direct relation between the elements)
- III. Some R is not W **False** (It is possible but not definite as there is no direct relation between the elements)

Hence, the correct answer is **None follows**.

**Comprehension :**

Direction: In the following question three statements are followed by three conclusions numbered I, II, and III. You have to take the given statements to be true even if they seem to be at variance from commonly known facts. Read all the statements and decide which of the given conclusion/conclusions logically follows from the given statements.

**Question 85 :**

Statements: All D are R Some R are T Only a few T are H Conclusions: I. Some D are T II. Some T are R III. Some T are not H

Difficulty : Moderate

Average Time : 94 Seconds

**Options :**

1. Only Conclusion I follows
2. Only Conclusion II follows

Both Conclusions I and II follow

4. Both Conclusions II and III follow

5. All follow

**Solution :**

The correct answer is **Option 4** i.e. **Both Conclusions II and III follow**

The Venn diagram for the given statements is:

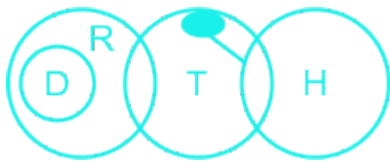
**Conclusions:**

I. Some D are T **False** (It is possible but not definite as there is no direct relation between the elements)

II. Some T are R **True** (As some R are T so some T are also R is true)

III. Some T are not H **True** (As Only a few T are H i.e. Some T are H and some T are not H, both are true.)

Hence, the correct answer is **Both Conclusions II and III follow**.

**Comprehension :**

Direction: In the following question three statements are followed by three conclusions numbered I, II, and III. You have to take the given statements to be true even if they seem to be at variance from commonly known facts. Read all the statements and decide which of the given conclusion/conclusions logically follows from the given statements.

**Question 86 :**

Statements: Only a few P are Q Some Q are R No R are S Conclusions: I. All P is S II. Some P is not S III. Some R is P

Difficulty : Moderate

Average Time : 98 Seconds

**Options :**

1. Only Conclusion I follows

2. Only Conclusion II follows

3. Either Conclusion I or II follows

4. All follow

5. None follows

**Solution :**

The correct answer is **Option 3** i.e. **Either Conclusion I or II follows**

The Venn diagram for the given statements is:

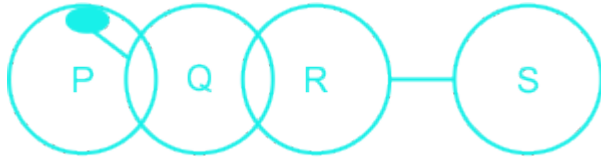
**Conclusions:**

- I. All P is S **False** (It is possible but not definite as there is no direct relation between the elements)
- II. Some P is not S **False** (It is possible but not definite as there is no direct relation between the elements)
- III. Some R is P **False** (It is possible but not definite as there is no direct relation between the elements)

Hence, the correct answer is **Either Conclusion I or II follows.**

**Question 87 :**

An owner sells the same article to two different people at different profit percentages. The first person buys the article at a profit of 20%, and the second person buys it at a profit of 40%. If the combined profit from both sales is Rs 60, find the cost price of the article.

**Difficulty : Moderate****Average Time : 83 Seconds****Options :**

- 1. Rs 100
- 2. Rs 200
- 3. Rs 300
- 4. Rs 80
- 5. Rs 90

**Solution :**

The correct answer is **option 1** i.e. **Rs 100.**

**Calculations:**

Let the cost price of the article be  $100x$ .

Selling price (When sold to first person) = 120% of  $100x$  =  $120x$

Selling price (When sold to second person) = 140% of 100x = 140x

Total cost price = 100x + 100x = 200x

Total selling price = 120x + 140x = 260x

According to the question;

Total profit = 260x - 200x

60x = 60

x = 1

Cost price of the article = 100x = Rs 100

### Comprehension :

Direction: Read the given information carefully and answer the following questions. There are eight people viz. J, K, L, M, N, O, P, and Q in a family and there are three generations in the family. J and K are the daughters-in-law of L, who is the sister-in-law of M. M is the only sister of N. O is the son of Q. Q is not married to K. There is no single parent in the family. N has no brother.

### Question 88 :

What is the relation of P with respect to O?

Difficulty : Moderate

Average Time : 80 Seconds

### Options :

1. Uncle
2. Aunt
3. Brother
4. Sister
5. Father

### Solution :

The correct answer is **Option 1** i.e. **Uncle**

1. J and K are the daughters-in-law of L, who is the sister-in-law of M.
2. M is the only sister of N.
3. N has no brother.



- O is the son of Q.
- Q is not married to K.
- There is no single parent in the family.

The possible family tree is as follows,

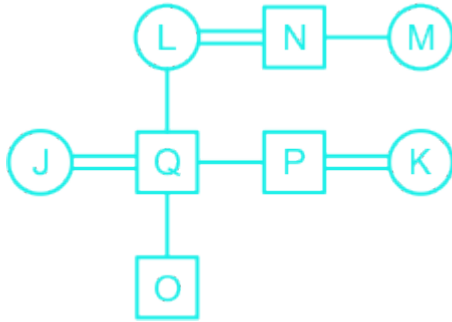

Clearly, P is the uncle of O.

Hence, the correct answer is **Uncle**.

**Comprehension :**

Direction: Read the given information carefully and answer the following questions. There are eight people viz. J, K, L, M, N, O, P, and Q in a family and there are three generations in the family. J and K are the daughters-in-law of L, who is the sister-in-law of M. M is the only sister of N. O is the son of Q. Q is not married to K. There is no single parent in the family. N has no brother.

**Question 89 :**

How many male members are in the family?

**Difficulty :** Moderate

**Average Time :** 85 Seconds

**Options :**

- 3
- 4
- 2
- 5
- More than 5

**Solution :**

The correct answer is **Option 2** i.e. 4

1. J and K are the daughters-in-law of L, who is the sister-in-law of M.
2. M is the only sister of N.
3. N has no brother.
4. O is the son of Q.
5. Q is not married to K.
6. There is no single parent in the family.

The possible family tree is as follows,

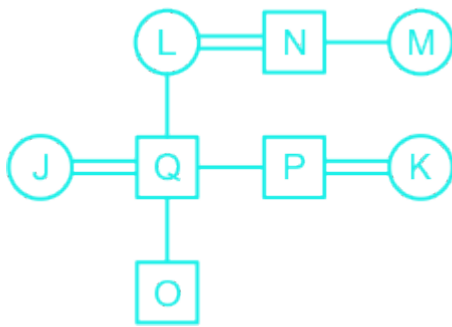

Clearly, 4 male members are in the family.

Hence, the correct answer is **4**.

### Comprehension :

Direction: Read the given information carefully and answer the following questions. There are eight people viz. J, K, L, M, N, O, P, and Q in a family and there are three generations in the family. J and K are the daughters-in-law of L, who is the sister-in-law of M. M is the only sister of N. O is the son of Q. Q is not married to K. There is no single parent in the family. N has no brother.

### Question 90 :

If R and O are cousins, then how K is related to R?

Difficulty : Moderate

Average Time : 85 Seconds

### Options :

1. Father
2. Uncle
3. Mother

Aunt

5. Brother

**Solution :**

The correct answer is **Option 3** i.e. **Mother**

1. J and K are the daughters-in-law of L, who is the sister-in-law of M.
2. M is the only sister of N.
3. N has no brother.
4. O is the son of Q.
5. Q is not married to K.
6. There is no single parent in the family.

The possible family tree is as follows,

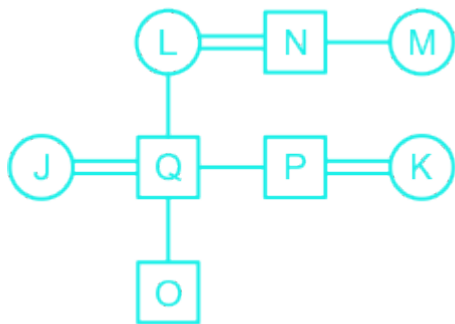

Clearly, if R and O are cousins then K is the mother of R.

Hence, the correct answer is **Mother**.

**Comprehension :**

Direction: In the given statement, the relationship between different elements is shown and it is followed by two conclusions. Choose the correct answer on the basis of the information given below.

**Question 91 :**

Statement:  $23 = 24$   $25 > 26$   $27$   $28 = 29 > 30$  Conclusions: I.  $24 > 27$  II.  $27 > 23$

Difficulty : Moderate

Average Time : 75 Seconds

**Options :**

1. Only Conclusion I follows



Only Conclusion II follows

3. Either Conclusion I or II follows

4. Neither Conclusion I nor II follows

5. Both Conclusions I and II follow

**Solution :**

The correct answer is **Option 3** i.e. **Either Conclusion I or II follows**

**Statement:**  $23 = 24$   $25 > 26$   $27$   $28 = 29$   $> 30$

**Conclusions:**

I.  $24 > 27$  **False** ( $24$   $25 > 26$   $27$ : Opposite signs between the elements)

II.  $27$   $23$  **False** ( $23 = 24$   $25 > 26$   $27$ : Opposite signs between the elements)

Clearly, conclusions I and II make complementary pairs.

Hence, the correct answer is **Either Conclusion I or II follows.**

**Comprehension :**

Direction: In the given statement, the relationship between different elements is shown and it is followed by two conclusions. Choose the correct answer on the basis of the information given below.

**Question 92 :**

Statements:  $A = B > C$ ,  $E > D$   $C, E > F > G = H$  Conclusions: I.  $A > E$  II.  $D > F$

Difficulty : Moderate

Average Time : 78 Seconds

**Options :**

1. Only Conclusion I follows

2. Only Conclusion II follows

3. Either Conclusion I or II follows

4. Neither Conclusion I nor II follows

5. Both Conclusions I and II follow

**Solution :**

The correct answer is **Option 5** i.e. **Both Conclusions I and II follow**

**Statements:**  $A = B > C$ ,  $E > D$   $C, E > F > G = H$

$$A = B > C > D \quad E \quad F > G = H$$

**Conclusions:**

I.  $A > E$  **True** ( $A = B > C > D \quad E$  i.e.  $A > E$ )

II.  $D \quad F$  **True** ( $D \quad E \quad F$  i.e.  $D \quad F$ )

Clearly, Both Conclusions I and II follow.

Hence, the correct answer is **Both Conclusions I and II follow.**

**Comprehension :**

Direction: In the given statement, the relationship between different elements is shown and it is followed by two conclusions. Choose the correct answer on the basis of the information given below.

**Question 93 :**

Statements:  $11 > 10 = 9$ ;  $11 \quad 12 \quad 13$ ;  $12 > 14 = 15$  Conclusions: II.  $34 > 30$  III.  $32 > 29$

Difficulty : Moderate

Average Time : 85 Seconds

**Options :**

1. Only Conclusion I follows
2. Only Conclusion II follows
3. Either Conclusion I or II follows
4. Neither Conclusion I nor II follows
5. Both Conclusions I and II follow

**Solution :**

The correct answer is **Option 3** i.e. **Either Conclusion I or II follows**

Statements:  $11 > 10 = 9$ ;  $11 \quad 12 \quad 13$ ;  $12 > 14 = 15$

$13 \quad 12 > 11 > 10 = 9$ ;  $12 > 14 = 15$

**Conclusions:**

II.  $14 > 10$  **False** ( $10 \quad 11 \quad 12 > 14$  i.e. Opposite sign between the elements)

III.  $15 \quad 10$  **False** ( $10 \quad 11 \quad 12 > 14 = 15$  i.e. Opposite sign between the elements)

Hence, the correct answer is **Either Conclusion I or II follows.**

**Question 94 :**



How many pairs of letters are there in the word "STANDARD" each of which has as many letters between them as in the English alphabetical series in both forward and backward directions?

**Difficulty : Moderate**

**Average Time : 68 Seconds**

**Options :**

1. 1
2. 2
3. 3
4. 4
5. More than 4

**Solution :**

The correct answer is **Option 1** i.e. 1

STANDARD



Clearly, 1 pair is there in the word STANDARD.

Hence, the correct answer is 1.

**Question 95 :**

In the given word "HUSBAND" if a vowel is replaced with its next letter and the consonant is replaced with its previous letter then which letter is fourth from the right end?

**Difficulty : Moderate**

**Average Time : 49 Seconds**

**Options :**

1. G
2. V
3. A
4. R
5. B

**Solution :**

The correct answer is **Option 3** i.e. **A**

H U S B A N D

After applying the operation,

G V R **A** B M C

Clearly, the fourth letter from the right end is A.

Hence, the correct answer is **A**.

### Comprehension :

Direction: Read the given information carefully and answer the following questions. An uncertain number of persons are sitting in a linear row and all are facing north. L sits third from the right end. Only one person sits between L and Q. N sits third to the left of Q. P sits immediately right of N. Three people sit between P and O. Two people sit between M and O and one of them sits at the end.

### Question 96 :

How many people are sitting in a linear row?

Difficulty : Moderate

Average Time : 66 Seconds

### Options :

1. 12
2. 14
3. 13
4. 11
5. 15

### Solution :

The correct answer is **Option 2** i.e. **14**

1. L sits third from the right end.
2. Only one person sits between L and Q. (Here, we have 2 Cases i.e. Case 1 and Case 2)
3. N sits third to the left of Q.

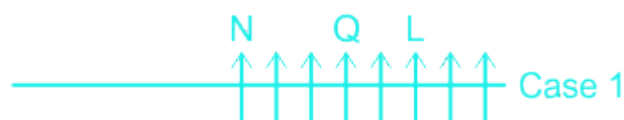



4. P sits immediately right of N.

Now, we can eliminate Case 2.

5. Three people sit between P and O.

6. Two people sit between M and O and one of them sits at the end.

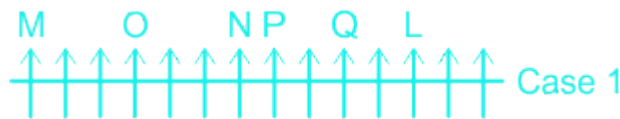

This is our final arrangement.

Clearly, 14 people are sitting in a row.

Hence, the correct answer is **14**.

### Comprehension :

Direction: Read the given information carefully and answer the following questions. An uncertain number of persons are sitting in a linear row and all are facing north. L sits third from the right end. Only one person sits between L and Q. N sits third to the left of Q. P sits immediately right of N. Three people sit between P and O. Two people sit between M and O and one of them sits at the end.

### Question 97 :

How many people sit between M and P?

Difficulty : Moderate

Average Time : 91 Seconds

### Options :

1. 2
2. 3
3. 4
4. 5
5. 6

### Solution :

The correct answer is **Option 5** i.e. 6



- L sits third from the right end.
- Only one person sits between L and Q. (Here, we have 2 Cases i.e. Case 1 and Case 2)
- N sits third to the left of Q.

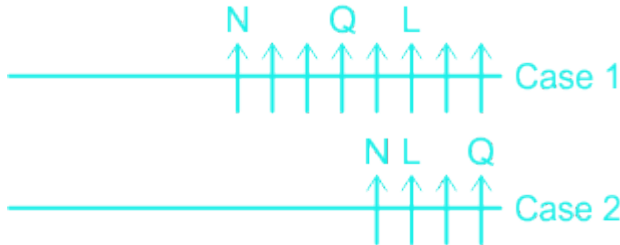

- P sits immediately right of N.
- Now, we can eliminate Case 2.
- Three people sit between P and O.
  - Two people sit between M and O and one of them sits at the end.



This is our final arrangement.

Clearly, 6 people are sitting between M and P.

Hence, the correct answer is **6**.

**Comprehension :**

Direction: Read the given information carefully and answer the following questions. An uncertain number of persons are sitting in a linear row and all are facing north. L sits third from the right end. Only one person sits between L and Q. N sits third to the left of Q. P sits immediately right of N. Three people sit between P and O. Two people sit between M and O and one of them sits at the end.

**Question 98 :**

How many people sit to the left of N?

Difficulty : Moderate

Average Time : 92 Seconds

**Options :**

- 2
- 3

4

4. 5

5. 6

**Solution :**

The correct answer is **Option 5** i.e. **6**

- L sits third from the right end.
- Only one person sits between L and Q. (Here, we have 2 Cases i.e. Case 1 and Case 2)
- N sits third to the left of Q.

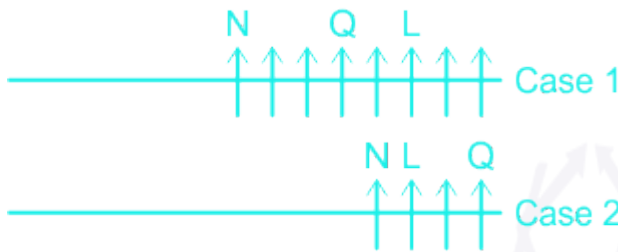

- P sits immediately right of N.

Now, we can eliminate Case 2.

- Three people sit between P and O.
- Two people sit between M and O and one of them sits at the end.

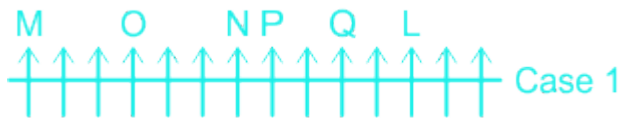

This is our final arrangement.

Clearly, 6 people sit to the left of N.

Hence, the correct answer is **6**.

**Question 99 :**

The salary of Rohan is Rs. 15000. From his salary, he spends some amount on transport and the amount spent on education is Rs. 2500 more than transport. He saves the remaining Rs. 5000. Find the ratio of the amount spent on transport to the amount spent on education.

**Difficulty : Moderate**

**Average Time : 84 Seconds**

**Options :**

1. 3 : 5
2. 7 : 5
3. 3 : 7
4. 5 : 3
5. 1 : 2

**Solution :**

The correct answer is **option 1** i.e. **3 : 5**.

**Calculations:**

Let the amount spent on transport be  $x$ .

Amount spent on education =  $x + 2500$

Amount left after saving Rs 5000 =  $15000 - 5000 = \text{Rs } 10000$

According to the question;

Amount spent on education and transport = 10000

$$x + x + 2500 = 10000$$

$$2x + 2500 = 10000$$

$$2x = 7500$$

$$x = 3750$$

Amount spent on transport =  $x = 3750$

Amount spent on education =  $x + 2500 = 6250$

Required ratio =  $3750 : 6250$

$$3 : 5$$

**Question 100 :**

An investor has a total of Rs. 6000, which they decide to invest in two different schemes: one offering 9% per annum and the other offering 6% per annum. If the total interest obtained from these investments in one year is Rs. 450, find the amount invested at 6% per annum.

**Difficulty : Moderate**

**Average Time : 62 Seconds**

**Options :**

1. Rs 2000
2. Rs 3000
3. Rs 1000
4. Rs 2500
5. Rs 3500

**Solution :**

The correct answer is **option 2** i.e. **Rs 3000**.

**Formula used:**

Simple interest =  $PRT/100$

Where, P = principal, R = rate and T = time period

**Calculations:**

Let the amount invested at 9% be x.

Amount invested at 6% =  $y = 6000 - x$

According to the question;

$$[(x \times 9)/100] + [(6000 - x) \times 6]/100 = 450$$

$$(9x/100) + 360 - (6x/100) = 450$$

$$3x/100 = 90$$

$$x = 3000$$

Required amount invested at 6% =  $6000 - 3000 = \text{Rs } 3000$

## Ibbs Clerk Prelims Previous Year Question Paper Analysis

The analysis of Ibbs Clerk Prelims Previous Year Question Paper held on 2023-10-27 in the Morning Shift exam is as follows:

1. 99 questions were moderate and 1 questions were hard.
2. The safe score is 73 marks.



, 35 questions were asked from Quantitative Aptitude, 30 questions were asked from English Language and 35 questions were asked from Logical Reasoning

4. 65 questions should have been skipped if you were short of time.

# Ibbs Clerk Prelims Previous Year Question Paper Topic Wise Weightage

## Quantitative Aptitude

1. Simplification - 15
2. Data Interpretation - 5
3. Time And Work - 1
4. Time Speed And Distance - 2
5. Interest - 1
6. Ratios And Proportion - 2
7. Number Series - 5
8. Partnership - 2
9. Profit And Loss - 1
10. Pipes And Cistern - 1



## English Language

1. Reading Comprehension - 6
2. Vocab - 4
3. Cloze Test - 5
4. Spotting Error - 5
5. Sentence Jumbles - 5
6. Sentence Improvement - 4

## Logical Reasoning

1. Arrangement And Pattern - 6
2. Seating Arrangement - 19
3. Blood Relations - 2
4. Inequality - 3
5. Puzzle - 5

# Ibps Clerk Prelims Previous Year Question Paper Tips and Tricks



1. Try to solve Ibps Clerk Prelims Previous Year Question Paper without taking any help from the solutions.
2. Ibps Clerk Prelims Previous Year Question Paper require proper usage of concept so firstly read the question thoroughly and then use the right concept.
3. In case you're not able to solve the question in less than 30 seconds in the exam then you should skip the question and move to the next question.

## Daily Current Affairs



KD Live is providing [Current Affairs](#) on a daily basis for Banking and a [Current Affairs Quiz](#) too for the practice.

## KD Live Free Offerings



KD Live is Offering Every Information and Study Material required for the self study. Please click on the following links for accessing those.

- [Study Plan](#)
- [General Science](#)
- [General Awareness](#)
- [General Knowledge](#)
- [Quantitative Aptitude](#)
- [Logical Reasoning](#)
- [English Language](#)
- [Today In History](#)
- [Syllabus](#)
- [Know Your State](#)
- [Know Your Country](#)
- [Know Your City](#)
- [Know Your Leader](#)
- [Books And Authors](#)
- [Daily Vocabulary](#)
- [Daily Editorial](#)
- [Latest Notifications](#)
- [Exam Dates](#)
- [Admit Card](#)
- [Exam Results](#)
- [Exam Cutoff](#)

[Exam Eligibility](#)[Exam Pattern](#)[Answer Key](#)[Important Days](#)[Full Form](#)[Government Schemes](#)[Previous Year PDF](#)[Quiz](#)[Courses](#)[Classes](#)

## Further Guidance on Ibps Clerk Prelims Previous Year Question Paper

For Asking any query on Ibps Clerk Prelims Previous Year Question Paper please mail [Send Email](#) or you can fill the form at [KD Live](#).

### About KD Live

KD live has an expertise in providing apt explanations for the Ibps Clerk Prelims Previous Year Question Paper since 2008. More than 10 lakh aspirants have cleared competitive exams under the guidance of Neetu Mam.

Study.kdcampus.live is providing free information on various topics and for the Ibps Clerk Exam you can refer the following link [Click Here](#) however if you want to practice more questions then please refer the following link [Click Here](#).

### About Neetu Mam

Neetu Mam is primarily passionate for the English language and teaching from the last 20 years however for the Ibps Clerk Prelims Previous Year Question Paper. She has guided her team to provide the best explanation for the question.